

FSN

4K UHD Monitor

Instructions for Use

FM-A2701D

FM-A2701DS

FM-B2702D

FM-B2702DG

FS-P3102D

FS-P3102DS

FS-P3102DG

FM-E3203D

FM-E3203DG



Before connecting, operating or adjusting this product, please read this instruction booklet carefully and completely.

English

Table of Contents

Product Description / Intended Use	3
Symbol Definitions	4
Warnings and Precautions	5
Safety Instructions	7
Electromagnetic Compatibility	10
Accessories	15
Mechanical Drawings	16-19
Controls	20
On Screen Display (OSD)	21, 22
Window Layout	23
Standard Signal Table	24
General Specifications	25-28
Cleaning Instructions	29

The specifications and information in this document are subject to change without notice.



Instructions for Use for this product are also available in electronic form (eIFU). Choose from several languages. Use Adobe Acrobat software to view eIFUs. Access the eIFUs online at fsnmed.com/support/eifu/

Product Description / Intended Use



This product from FSN Medical Technologies is a high-end surgical display monitor designed for advanced digital OR applications. This medical display is uniquely equipped to handle tasks in the demanding operating room environment. Performance characteristics include:

- Rapid signal detection, robust mode tables
- Artifact-free images
- Fanless - sterile field compatible
- Calibrated to clinical color
- Zoom, freeze, picture-in-picture

Intended Purpose

This device is intended to be connected to other medical equipment, and to display images or videos from endoscopic cameras, room cameras, and patient information such as ultrasound, cardiology, and anesthesiology. This device is not intended for diagnosis. This device is intended to be compatible with other highly specialized surgical and diagnostic equipment used in surgical suites, operating rooms, emergency rooms, and procedural facilities.

Intended Use Environment

This device is intended to be used by a trained medical professional in a healthcare facility setting where contact with a patient is unlikely (no applied part).

This device is designed to meet the medical safety requirements for a patient vicinity device.

































Warning: This device may not be used in connection with life support equipment.

Indications for Use

This device is to be used by a trained medical professional to display images from procedures, such as endoscopy, ultrasound, cardiology, and anesthesiology. This device connects to medical imaging equipment to display images, videos or patient information during surgical procedures. This device is not intended for diagnosis.

Symbol Definitions

The following symbols appear on the product, its labeling, or the product packing. Each symbol carries a special definition, as defined below:

	Dangerous : High Voltage		Power adapter		Consult accompanying documents
	Direct current		Indicates equipotential earth ground		Unique Device Identifier
	Indicates protective earth ground		Indicates top-bottom direction		Korea Certification
	DC Power control switch		Fragile		Approved according to the CCC regulations
	Do not get wet		Maximum Stacking		China RoHS labels
	Consult the operating instructions		Indicates the manufacturer		Catalog Number
	Indicates the manufacturing date		Authorized representative in the European community		Medical Device
	Serial Number		Humidity limitation		Consult the operating instructions - electronic
	Temperature limitation		Atmospheric pressure limitation		Importer Entity
	UK Conformity Assessed				
	Indicates proof of conformity to EU 2017/745 Medical Devices Regulation and applicable standards.				
	Medical Equipment is in accordance with ANSI/AAMI ES60601-1 (2005) + AMD 1 (2012) and CAN/CSA-C22.2 No. 60601-1 (2014) in regards to electric shock, fire hazards, and mechanical hazard.				
	Tested to comply with FCC Class B standard (USA).				
	Waste electrical and electronic equipment (WEEE Directive 2012/19/EU). This symbol indicates that the waste of electronic equipment must not be disposed as unsorted municipal waste and must be collected separately. Please contact the manufacturer or other authorized disposal company to decommission your equipment.				

Note: A printed copy of the manual in English is provided with the product. Users within EU member states, please contact local distributor for other languages. This applies to EU member states where the product has been purchased through authorized channels.

Warnings and Precautions

Caution Information



This symbol alerts the user that important literature concerning the operation of this unit has been included. Therefore, it should be read carefully in order to avoid potential problems.



This symbol warns users that un-insulated voltage within the unit may have sufficient magnitude to cause electrical shock. Therefore, it is dangerous to make contact with any part inside the unit. To reduce the risk of electrical shock, DO NOT remove cover (or back). There are no user-serviceable parts inside. Refer servicing to qualified service personnel.

To prevent fire or shock hazards, do not expose this unit to rain or moisture. Do not use this unit's polarized plug with an extension cord receptacle or other outlets unless the prongs can be fully inserted.



Underwriters Laboratories (UL) Classification:

UL safety Compliance:

This medical LCD monitor is U.L. Classified WITH RESPECT TO ELECTRIC SHOCK, FIRE AND MECHANICAL HAZARDS ONLY IN ACCORDANCE WITH UL 60601-1/CAN/CSA C22.2 NO. 601.1



EU Conformity and EMC Compliance:

This medical LCD monitor unit meets the requirements of EN60601-1 and EN60601-1-2 so as to conform to the EU Medical Devices Regulation (MDR 2017/745). CE class I medical device accessory.

This medical LCD monitor complies to the above standards only when used with the supplied medical grade power supply. Use 120V rating 5-15P type plug only in the U.S.

ATM160T-P240

Caution: Make sure the power cord is the correct type that is required in your geographic area. This medical LCD monitor has a universal power supply that allows operation in either 100-120V AC or 200-240V AC voltage areas (no user adjustment is required).

Use the proper power cord with correct attachment plug type. If the power source is 120 V AC, use a power cord which is a Hospital Grade Power Cord with NEMA 5-15 style plug, labeled for 125 volts AC with UL and C-UL approvals. If the power source is a 240 V AC supply, use the tandem (T blade) type attachment plug with ground conductor power cord that meets the respective European country's safety regulations.

A ground post, located on the back of the display, may be used for the purpose of grounding the display's chassis. Any such ground must be installed in accordance with applicable electrical codes. The ground post is shown on the mechanical drawing found in this instructions for use.



Recycling (WEEE Directive 2012/19/EU)

Follow local governing ordinances and recycling plans regarding the recycling or disposal of this equipment.

Warning: Use of this equipment adjacent to or stacked with other equipment should be avoided because it could result in improper operation. If such use is necessary, this equipment and the other equipment should be observed to verify that they are operating normally.

Warning: Use of accessories, transducers and cables other than those specified or provided by the manufacturer of this equipment could result in increased electromagnetic emissions or decreased electromagnetic immunity of this equipment and result in improper operation.

Warning: Portable RF communications equipment (including peripherals such as antenna cables and external antennas) should be used no closer than 30 cm (12 inches) to any part of this medical LCD monitor, including cables specified by the manufacturer. Otherwise, degradation of the performance of this equipment could result.

Warning: Using this equipment in the X-ray or magnetic resonance environment could result in degradation of the performance of this equipment, interference with other equipment or interference with radio services.

Warning: The use of cables and/or other accessories with this device, other than those specified, may result in increased emissions or decreased immunity of this device.

Warning: This product is not considered physically to connect to HF (High Frequency) electrosurgical equipment.

Warning: Not suitable for use in the presence of a flammable anesthetics mixture with oxygen or with nitrous oxide.

Safety Instructions

On Safety

1. Before connecting the AC power cord to the DC adapter outlet make sure the voltage designation of the DC adapter corresponds to the local electrical supply.
2. Never insert anything metallic into the cabinet openings of the medical LCD monitor. Doing so may create the danger of electric shock.
3. To reduce the risk of electric shock, do not remove cover. No user-serviceable parts inside. Only a qualified technician should open the case of the medical LCD monitor.
4. Never use your medical LCD monitor if the power cord has been damaged. Do not allow anything to rest on the power cord, and keep the cord away from areas where people can trip over it.
5. Be sure to hold the plug, not the cord, when disconnecting the medical LCD monitor power cord from an electric socket.
6. Unplug your medical LCD monitor power cord when it is going to be left unused for an extended period of time.
7. Unplug your medical LCD monitor power cord from the AC outlet before any service.
8. If your medical LCD monitor does not operate normally, in particular, if there are any unusual sounds or smells coming from it, unplug it immediately and contact an authorized dealer or service center.
9. Please contact the manufacturer if the set should be installed in an inaccessible area.

Warning: Do not touch input or output connectors and the patient simultaneously.

Warning: This medical LCD monitor is intended for connection to input/output signals and other connectors that comply with relevant IEC standard (e.g., IEC60950 for IT equipment and IEC60601 series for medical electrical equipment). In addition, all such combination-system shall comply with the standard IEC 60601-1-1 or clause 16 of the 3 Ed. of IEC 60601-1, respectively, safety requirements for medical electrical systems. Any person who has formed a combination-system is responsible for the system to comply with the requirements of IEC 60601-1-1 or clause 16 of the 3 Ed. of IEC 60601-1, respectively. If in doubt, contact qualified technician or your local representative.

Warning: To avoid risk of electric shock, this equipment must only be connected to a supply mains with protective earth. Power supply (AC/DC Adapter) is specified as a part of the LCD Color Display. Do not position equipment in such a way that it is difficult to disconnect the power cord plug from the appliance inlet.

Warning: Do not modify this equipment without authorization of the manufacturer.

Product fuse has a lower breaking capacity. Do not install at the building power system, prospective short-circuit current exceeding 35 A.

Environmental Conditions for Operation and Storage

Temperature range within 0°C to 40°C(operation), -20°C to 60°C (storage)

Relative humidity range 10% to 85%

Atmospheric pressure range within 500 to 1060hPa.

On Installation

1. Openings in the medical LCD monitor cabinet are provided for ventilation. To prevent overheating, these openings should not be blocked or covered. If you put the medical LCD monitor in a bookcase or some other enclosed space, be sure to provide adequate ventilation.
2. Do not expose the medical LCD monitor to rain or use it near water. If the medical LCD monitor accidentally gets wet, unplug it and contact an authorized dealer immediately. You can clean the medical LCD monitor with a damp cloth if necessary, but be sure to unplug the medical LCD monitor first.
3. Place your medical LCD monitor near an easily accessible AC outlet.
4. High temperature can cause problems. Max operating temperature is 40°C. Don't use your medical LCD monitor in direct sunlight and keep it away from heaters, stoves, fireplaces, and sources of heat.
5. Don't place your medical LCD Monitor on an unstable stand, Medical LCD monitor may malfunction or fall.
6. This medical LCD monitor should not topple over when tilted at a 5° angle, in any position, during NORMAL USE, excluding transport.
7. In the position specified for transport, medical LCD monitor shall not overbalance when tilted at a 10 degree angle.
8. When carrying this product, please use both handles (if included) on the left and right side of the product, and carry using two people. If you want the product to be installed in another place, please call your service center.
9. Always use only the original cables and accessories with the device.
10. Do not lay this monitor on other equipment.

Repair

Do not attempt to service the medical LCD monitor yourself, as opening or removing covers may expose you to dangerous voltages or other hazards, and will void the warranty. Refer all servicing to qualified service personnel. Unplug the medical LCD monitor from its power source and refer servicing to qualified personnel under the following conditions:

- If the power cord or plug is damaged or frayed.
- If liquid has been spilled into the medical LCD monitor.
- If objects have fallen into the medical LCD monitor.
- If the medical LCD monitor has been exposed to rain or moisture.
- If the medical LCD monitor has been subjected to excessive shock by being dropped.
- If the cabinet has been damaged.
- If the medical LCD monitor seems to be overheated.
- If the medical LCD monitor emits smoke or abnormal odor.
- If the medical LCD monitor fails to operate in accordance with the operating instructions.

Biohazards

To prevent spreading of infections, this device should only be used in environments where biological decontamination can be successfully performed.

Returned Product

After troubleshooting, if problems persist, disinfect the monitor and return it to FSN using the original packaging. Include the accessories that came with the monitor in the return shipment. Please enclose a brief explanation of the malfunction.

Contact FSN Medical Technologies for a Return Authorization Number and instructions, prior to returning the device.

Accessories

Use only accessories specified by the manufacturer, or sold with the medical LCD monitor.

Classification for Safety Compliance

- Protection against electric shock : Class I including AC/DC adapter. This medical equipment is in accordance with ANSI/AAMI ES60601-1 (2005) + AMD 1 (2012) and CAN/CSA-C22.2 No. 60601-1 (2014) in regards to electric shock, fire hazards, and mechanical hazard.
- Applied Parts : No Applied Parts.
- Degree of safety in the presence of flammable anesthetics mixture with air or with oxygen or with nitrous oxide. Not suitable for use in the presence of a flammable anesthetics mixture with oxygen or with nitrous oxide.
- For critical applications, it is recommended to have a replacement monitor available.
- Mode of operation : Continuous.

Notice to the user:

Any serious incident that has occurred in relation to the device should be reported to the manufacturer and the competent authority of the Member State in which the user and/or patient is established. Contact your local FSN Medical Technologies sales representative for information on changes and new products.

Electromagnetic Compatibility

This medical monitor unit has been designed and tested to comply with IEC 60601-1-2:2014/AMD1:2020 requirements for EMC with other devices. To ensure electromagnetic compatibility (EMC), the monitor must be installed and operated according to the EMC information provided in this Instructions for Use.

This medical monitor unit has been tested and found to comply with the limits of a Class B digital device, pursuant to Part 15 of the FCC rules. These limits are designed to provide reasonable protection against interference. This monitor can radiate radio frequency energy and, if not installed and used in accordance with the instructions, it may interfere with other radio communications equipment. There is no guarantee that interference will not occur in a particular installation. If this equipment is found to cause harmful interference to radio or television reception, the user is encouraged to try to correct the interference by carrying out one or more of the following measures:

1. Reorient or relocate the receiving antenna.
2. Increase the distance between the medical LCD monitor and the subject of interference.
3. Plug the monitor into an outlet on a different electrical circuit than that to which the subject of interference is connected.
4. Consult the dealer or an experienced radio/TV technician for help.

NOTICES TO USER

This device complies with part 15 of the FCC Rules. Operation is subject to the following two conditions: (1) this device may not cause harmful interference, and (2) this device must accept any interference received, including interference that may cause undesired operation.

FCC WARNING

This medical LCD monitor generates or uses radio frequency energy. Changes or modifications to this medical LCD monitor may cause harmful interference unless the modifications are expressly approved in the instruction manual. The user could lose authority to operate this equipment if an unauthorized change or modification is made.

PRODUCT LIFETIME

The performance of LCD panels may deteriorate over long periods of time. Periodically check that this monitor is operating correctly. The expected service life of the device is four years. Keep the monitor clean to prolong its operational lifetime.

1. Guidance and manufacturer's declaration - electromagnetic emission

The medical LCD monitor is intended for use in the electromagnetic environment specified below. The user of the device should make sure that the medical LCD monitor is operated in such an environment.		
Interference emission measurements	Conformity level	Electromagnetic environment -guidance
RF emissions acc. to CISPR 11	Complies with Group 1	The characteristics of this device determined by broadcasting permit its industrial and hospital use (CISPR 11, Class A). When used in a living area (for which CISPR 11 usually requires Class B), this device may not provide adequate protection of radio services. The user must, if necessary, take remedial action such as implementation or reorientation of the device.
RF emissions acc. to CISPR 11	Complies with Class B	
Emission of harmonic oscillations acc. to IEC 61000-3-2	Complies with Class A	
Voltage fluctuations/flicker emissions acc. to IEC 61000-3-3	Complies	

2. For the use of ME devices in professional healthcare facilities. Guidance and manufacturer's declaration - electromagnetic immunity

The medical LCD monitor is intended for use in the electromagnetic environment specified below. The user of the medical LCD monitor should make sure that it is used in such an environment.		
Interference immunity test	IEC 60601-1-2:2014 conformity level	Electromagnetic environment-guidance
Electrostatic discharge (ESD) acc. to IEC 61000-4-2	Complies ± 2 kV, ± 4 kV, ± 6 kV, ± 8 kV contact discharge ± 2 kV, ± 4 kV, ± 8 kV, ± 15 kV air discharge	Floors should be made of wood, concrete or ceramic tile. If floors are covered with synthetic material, the relative humidity must be at least 30%
Rapid transient electric interferences/ bursts acc. to IEC 61000-4-4	Complies ± 2 kV for mains lines ± 1 kV for input/output lines	The quality of the supply voltage should correspond to that of a typical business or hospital environment.
Surge acc. to IEC 61000-4-5	Complies ± 1 kV push-pull voltage ± 2 kV common-mode voltage	The quality of the supply voltage should correspond to that of a typical business or hospital environment.
Voltage dips, short interruptions and fluctuations of the supply acc. to IEC 61000-4-11	0% U_T^* ; 0.5 cycle At 0°, 45°, 90°, 135°, 180°, 225°, 270°, 315° 0% U_T ; 1 cycle and 70% U_T ; 25/30 cycles Single phase: at 0° 0% U_T ; 250/300 cycle	Mains power quality should be that of a typical commercial or hospital environment. If the user of the device requests continued functioning even when interruptions of the power supply occur, it is recommended that the device be supplied from a power supply that is free of interruptions.
*Note: U_T is the mains alternating voltage before applying the test levels.		

**3. For the use of ME devices in professional healthcare facilities.
Test specification for ENCLOSURE PORT IMMUNITY to RF wireless communications equipment (according to IEC 60601-1-2:2014)**

The medical LCD monitor is intended for use in the electromagnetic environment specified below. The user of the medical LCD monitor should make sure that it is used in such an environment.						
Test frequency MHz	Band MHz	Service	Modulation	Maximum power W	Distance m	IMMUNITY TEST LEVEL V/m
385	380 to 390	TETRA 400	Pulse modulation 18 Hz	1.8	1.0	27
450	430 to 470	GMRS 460, FRS 460	FM ± 5 kHz stroke ± 1 kHz sine wave	2	1.0	28
710	704 to 787	Band 13, 17	Pulse modulation 217 Hz	0.2	1.0	9
745						
780						
810	800 to 960	GSM 800/900 TETRA 800, iDEN 820, CDMA 850, LTE Band 5	Pulse modulation 18 Hz	2	1.0	28
870						
930						
1720	1700 to 1990	GSM 1800, CDMA 1900, GSM 1900, DECT, LTE Band 1,3, 4, 25 UMTS	Pulse modulation 217 Hz	2	1.0	28
1845						
1970						
2450	2400 to 2570	Bluetooth, WLAN 802.11 b/g/n, RFID 2450, LTE Band 7	Pulse modulation 217 Hz	2	1.0	28
5240	5100 to 5800	WLAN 802.11 a/n	Pulse modulation 217 Hz	0.2	1.0	9
5500						
5785						
*Note: If necessary to achieve the IMMUNITY TEST LEVEL, the distance between the transmitting antenna and the medical LCD monitor may be reduced to 1 m. The 1 m test distance is permitted by IEC 61000-4-3.						

4. Guidance and manufacturer's declaration – electromagnetic immunity – for equipment and systems that are not life-supporting

The medical LCD monitor is intended for use in the electromagnetic environment specified below. The user of the medical LCD monitor should make sure that it is used in such an environment.			
Interference immunity tests	IEC 60601-1-2:2014 test level	Conformity level	Electromagnetic environment – guidelines
<p>Conducted RF disturbances acc. to IEC 61000-4-6</p> <p>Radiated RF disturbances according to IEC 61 000-4-3</p>	<p>3 V rms 150 kHz to < 80 MHz</p> <p>3 V/m 80 MHz to 2.5 GHz</p>	<p>3 V eff</p> <p>3 V/m</p>	<p>Portable and mobile RF communications equipment should be used no closer to any part of the medical LCD monitor, including cables, than the recommended separation distance calculated from the equation applicable to the frequency of the transmitter.</p> <p>Recommended separation distance:</p> $d = 1.2 \sqrt{P}$ <p>Where P is the nominal power of the transmitter in watts [W] according to the information provided by the manufacturer of the transmitter and d is the recommended separation distance in meters [m].</p> <p>The field strength of stationary transmitters at all frequencies on site a should be, according to a study, less than the conformity level b.</p> $d = 1.2 \sqrt{P}$ <p>80 MHz to < 800 MHz</p> $d = 2.3 \sqrt{P}$ <p>800 MHz to 2.5 GHz</p> <p>Interference may occur in the vicinity of equipment marked with the following symbol:</p> 
<p>Note: These guidelines may not apply in all situations. The propagation of electromagnetic quantities is affected by absorptions and reflections of buildings, objects, and persons.</p>			
<p>a Field strengths from fixed transmitters, such as base stations for radio [cellular/cordless] telephones and land mobile radios, amateur radio, AM and FM radio broadcast and TV broadcast cannot be predicted theoretically with accuracy. To assess the electromagnetic environment of the stationary transmitters, a site survey should be considered. If the measured field strength in the location at which the device is used exceeds the above conformity levels, the device should be observed to verify normal operation. If unusual performance characteristics are observed, additional measures may be necessary, such as a modified orientation or a different location for the device.</p> <p>b Over the frequency range 150 kHz to 80 MHz, field strengths should be less than 3 V/m.</p>			

5. Recommended separation distances between portable and mobile RF communications equipment and the medical LCD monitor

The medical LCD monitor is intended for use in the electromagnetic environment in which the RF disturbances are controlled. The user of the device can help prevent electromagnetic interference by maintaining a minimum distance between portable and mobile RF communications equipment (transmitters) and the device – as a function of the output power of the communication device, as shown below.

Nominal power of transmitter [W]	Separation distanced [m] according to frequency of transmitter		
	150kHz to< 80 MHz $d = 1.2 \sqrt{P}$	80 MHz to< 800 MHz $d = 1.2 \sqrt{P}$	800 MHz to 2.5 GHz $d = 2.3 \sqrt{P}$
0.01	0.12	0.12	0.23
0.1	0.38	0.38	0.73
1	1.2	1.2	2.3
10	3.8	3.8	7.3
100	12	12	23

For transmitters rated at a maximum output power not listed above, the recommended separation distance **d** in meters (m) can be estimated using the equation applicable to the frequency of the transmitter, where **P** is the maximum output power rating of the transmitter in watts (W) according to the transmitter manufacturer.



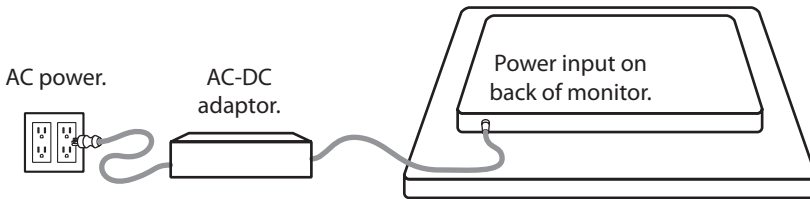

Connecting the Power Supply



Monitor	Maximum DC Extension Cable Length* (feet)
FM-A2701D, FM-A2701DS, FM-B2702D, FM-B2702DG, FS-P3102D, FS-P3102DS, FS-P3102DG, FM-E3203D, FM-E3203DG	75

* If longer extension is used, there is a risk of abnormal operation of the product.

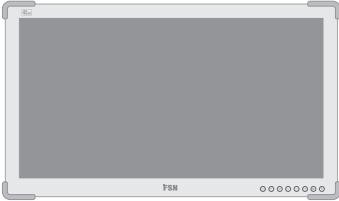
Accessories

Item	IFU	AC-DC Adaptor 6.23ft/1.9m	AC Power Cord 6ft/1.8m*	HDMI Cable	DVI-D Cable	Display-Port Cable	SDI BNC Cable x 4	Mounting Screws
 27" FM-A2701D 27" FM-A2701DS	■ ■	■ ■	■ ■	■ ■	■ ■	■ ■	■ ■	■ ■
 27" FM-B2702D 27" FM-B2702DG	■ ■	■ ■	■ ■	■ ■	■ ■	■ ■	■ ■	■ ■
 31" FS-P3102D 31" FS-P3102DS, 31" FS-P3102DG	■ ■	■ ■	■ ■	■ ■	■ ■	■ ■	■ ■	■ ■
 32" FM-E3203D 32" FM-E3203DG	■ ■	■ ■	■ ■	■ ■	■ ■	■ ■	■ ■	■ ■

* US,UK,EU, China. Hospital grade.

FM-A2701D

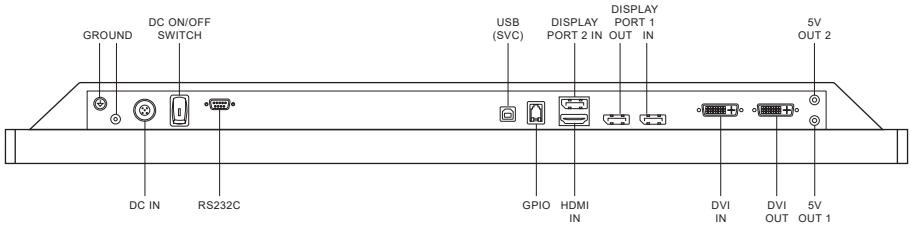
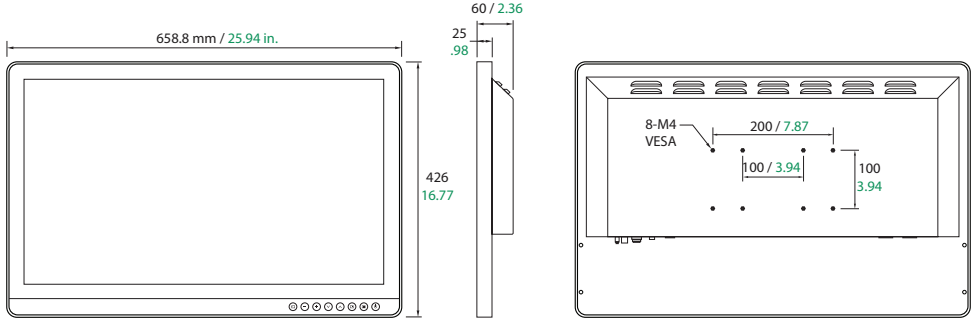

FM-A2701DS

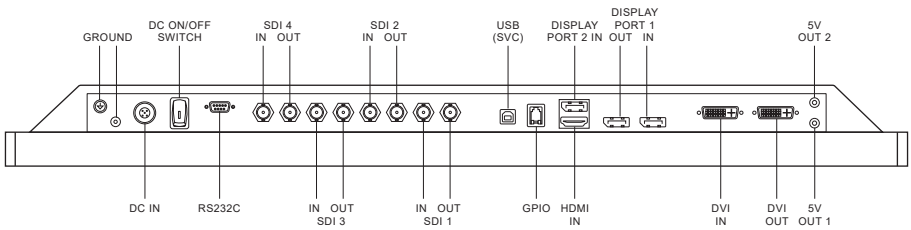

FM-B2702D

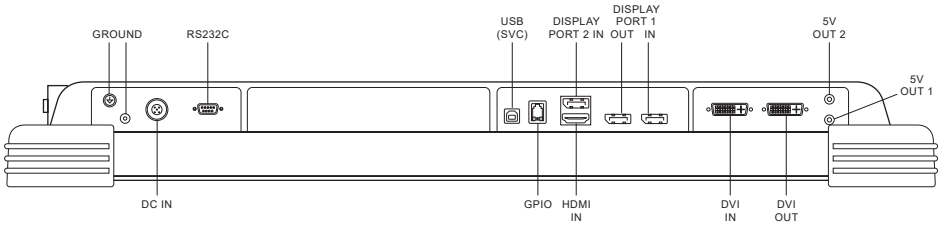
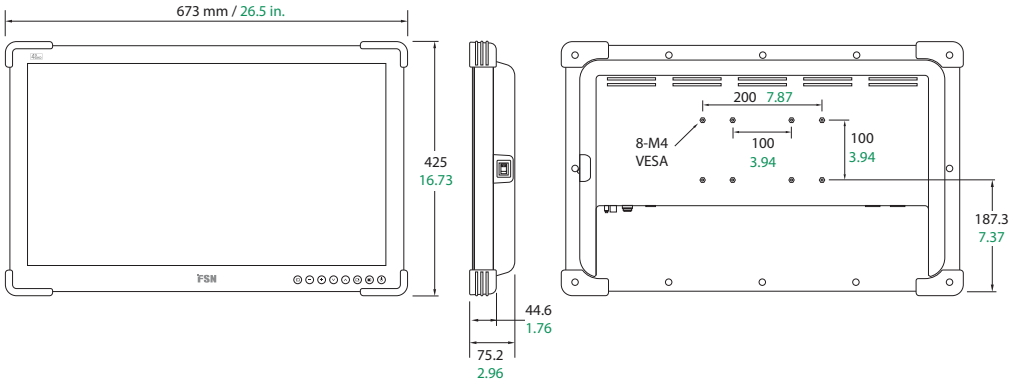

FM-B2702DG

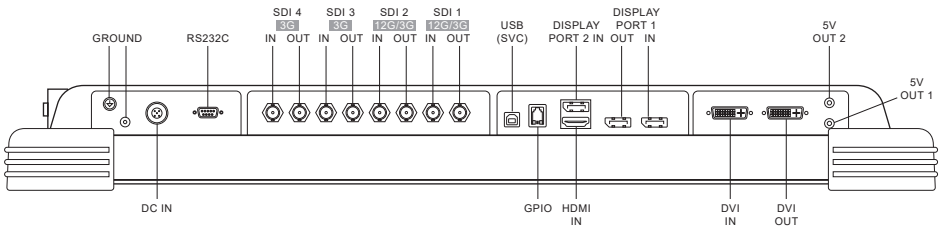

FS-P3102D

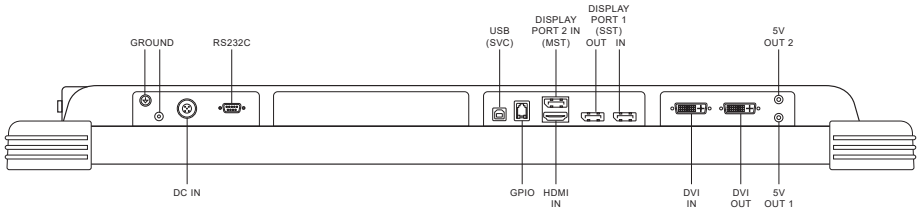
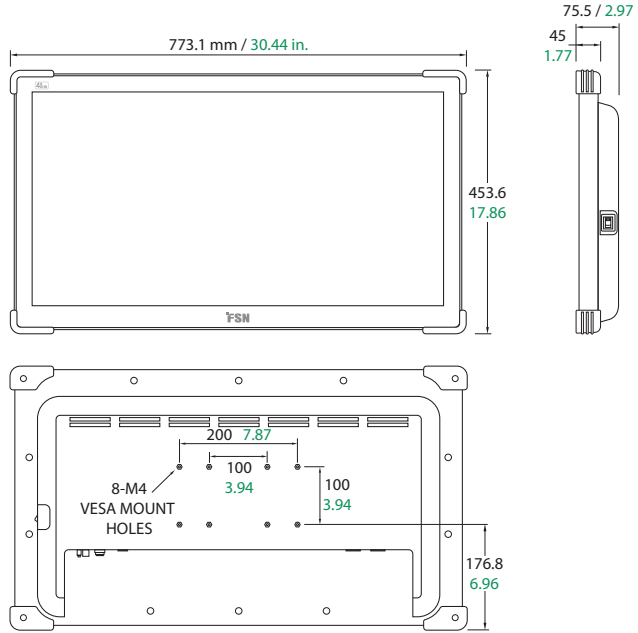

FS-P3102DS

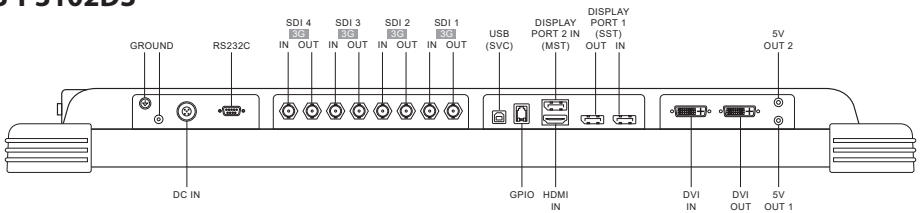

FS-P3102DG

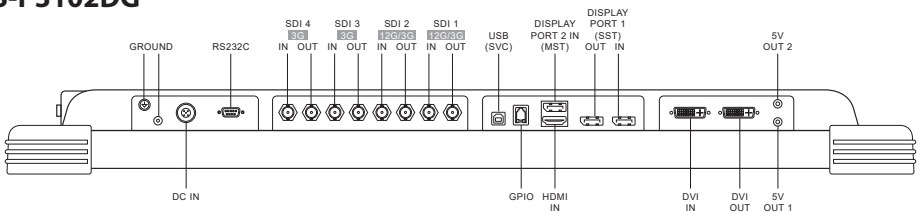

FM-E3203D

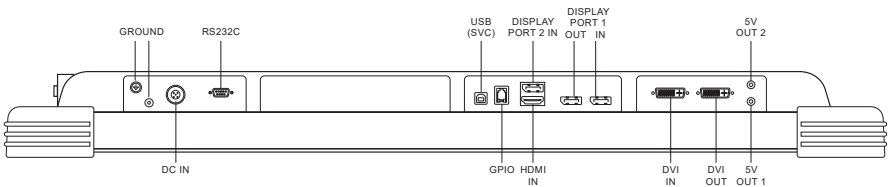
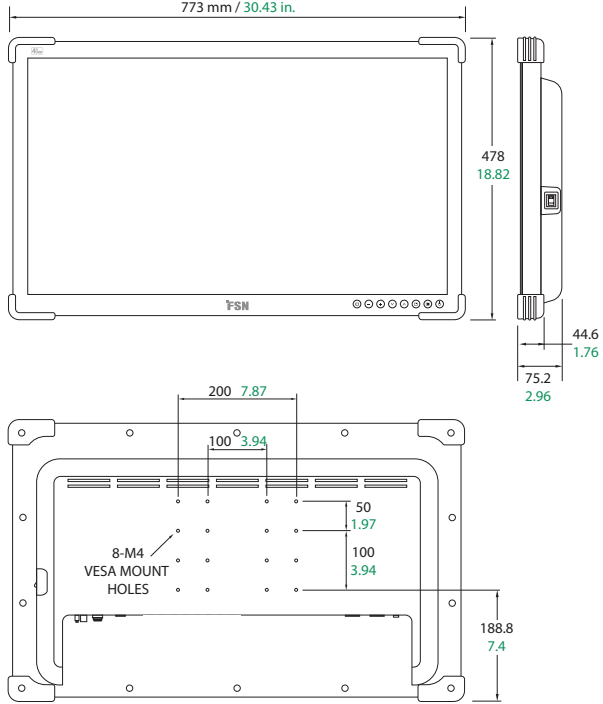



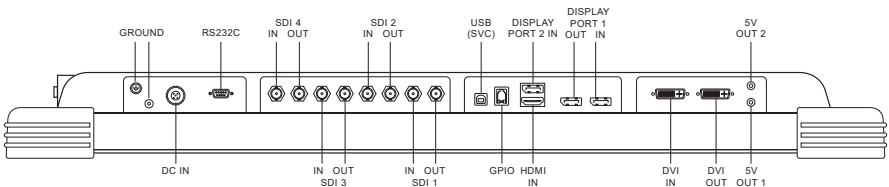





FM-E3203DG



Controls

On Screen Display (OSD)

<p>When the OSD menu is activated, press to decrease the adjustment of the selected function.</p>	<p>When the OSD menu is activated, press to move the menu selection downward.</p>	<p>Press to enable PIP (Picture in Picture) function.</p> <p>Not available when Smart Input is enabled.</p>	<p>Press to turn power on/off to the display's front LCD screen.</p> <p>If this icon is not illuminated, then the power switch on the back of the display has been turned off.</p>
 <p>INPUT</p>  <p>MINUS</p>	 <p>PLUS</p>  <p>DOWN</p>	 <p>UP</p>  <p>PIP</p>	 <p>MENU</p>  <p>POWER</p>
<p>Press to show the input selection menu and to change the display signal source.</p> <p>Press UP or DOWN, then press PLUS to select the desired source.</p>	<p>When the OSD menu is activated, press to enter sub menu, or increase the adjustment of the selected function.</p>	<p>When the OSD menu is activated, press to move the menu selection upward.</p>	<p>Press to activate the OSD menu.</p> <p>When the OSD menu is active, press to exit from the main menu or submenu.</p>
<p>Press PLUS and UP together to enable or disable the key lock function.</p>			

On Screen Display (OSD) Menus

FSN display monitors come equipped with a rich set of features for system set-up, image adjustments, and screen layout control. These features are managed through the On Screen Display, or OSD. Some options presented in the OSD are contextual and vary depending on the active input signal. See the Controls section for a complete description of each OSD button.

1. Enter the OSD

To activate the OSD menu, press the MENU button on the front of the display monitor. To close the OSD menu, press the menu button to exit from the main menu or a sub menu.



2. Pick a Main Menu Category

After entering the OSD, use the UP **▲** and DOWN **▼** buttons on the front of the display monitor to navigate to a main menu category: PICTURE, COLOR, ADVANCED, SETUP or LAYOUT.

3. Pick a Submenu Category

After entering the desired main menu category, press the **+** button to enter the submenus associated with the selected main menu. Use the UP **▲** and DOWN **▼** buttons to navigate to the desired submenu, then adjust as needed with the **+** and **-** buttons. Select the MENU button to exit from the submenu or main menu.

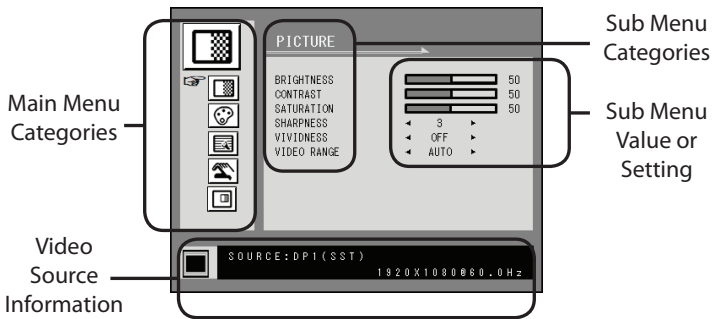

Submenus under the PICTURE menu

1. **BRIGHTNESS** Increases or decrease the brightness. (Range : 0~100)
2. **CONTRAST** Increases or decreases the contrast. (Range : 0~100)
3. **SATURATION** Increases or decreases the saturation. (Range : 0~100)
4. **SHARPNESS** Increases or decreases the sharpness. (Range : 0~4)
5. **VIVIDNESS** Sets image vividness. (Off, Low, Mid, High) Enhances image quality with minimal artificial effects.
6. **VIDEO RANGE** Select a video range setting. (0~255, 16~235, or AUTO)
0~255: for RGB format setting.
16~236: for YUV format setting.
AUTO: automatically changes to 0~255 for RGB format, or to 16~235 for YUV format.

On Screen Display (OSD) Menus



Submenus under the COLOR menu

1. **GAMMA** Select the appropriate gamma. (BYPASS,1.8, 2.0, 2.2, 2.4, 2.6, DICOM). Gamma cannot be changed when color space is BT.709.
2. **COLOR SPACE** Select the color space setting. (NATIVE, BT.709, BT.2020, or AUTO)
NATIVE: for native color setting.
BT.709: for HD signal setting.
BT.2020: for UHD signal setting.
AUTO: automatically changes to BT.2020 for UHD, or BT.709 for HD signal.
3. **COLOR MODE** Changes the image color setting. (C1, C2, C3, USER)
4. **RED** Red balance. (Only works with USER mode) (Range : 0~100)
5. **GREEN** Green balance. (Only works with USER mode) (Range : 0~100)
6. **BLUE** Blue balance. (Only works with USER mode) (Range : 0~100)



Submenus under the ADVANCED menu

1. **ASPECT RATIO** Changes aspect ratio of the displayed image. (Full, Auto, Fill-H)
2. **OVER SCAN** Adjusts the displayed size. (0~6)
3. **FREEZE** Keeps the image still.
4. **ROTATE/MIRROR** Changes the displayed image direction. (Normal, 180, H-Mirror, V-Mirror)
5. **SMART INPUT** Enables automatic switch to the backup source when main source is off.
6. **SMART MAIN** When smart input is on, current source is changed to main source.
7. **SMART 2ND** When smart input is on, backup source is set to 2nd source.



Submenus under the SETUP menu

1. **LANGUAGE** Changes the OSD language. (10 languages)
2. **OSD OVERLAY** Adjusts the OSD transparency.
3. **OSD POSITION** Changes the OSD position. (9 Positions)
4. **OSD MENU TIME** Adjusts the length of time the OSD Menu is present on the screen. (range: 10~60 seconds)
5. **BACKLIGHT** Increases or decreases the backlight. (Range : 0~100)
6. **POWER ON DC5V** Enables or disables the DC5V output.
7. **RESET** Changes all the OSD values to factory default.



Submenus under the LAYOUT menu - Single

1. **LAYOUT** Changes the image layout. (SINGLE, PBP, PIP)

Submenus under the LAYOUT menu - PBP

1. **LAYOUT** Changes the image layout. (SINGLE, PBP, PIP)
2. **WINDOW SELECT** Selects the active window during PBP or PIP.
3. **INPUT SWAP** Swaps the position of the primary and secondary images.

Submenus under the LAYOUT menu - PIP

1. **LAYOUT** Changes the image layout. (SINGLE, PBP, PIP)
2. **WINDOW SELECT** Selects the active window during PBP or PIP.
3. **INPUT SWAP** Swaps the position of the primary and secondary images.
4. **PIP SIZE** Changes the PIP size. (range : 0~10)
5. **PIP POSITION** Changes the PIP position. (L-Top, R-Top, Mid, L-Bot, R-Bot)
6. **PIP OVERLAY** Change the transparency of PIP image. (range : 0~8)

Window Layout

Single Window



Picture in Picture (PIP)

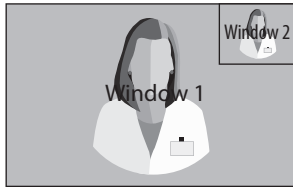

Picture by Picture (PBP)

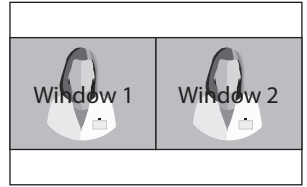

SDI Source Compatibility

3G-SDI Single (1080p 60Hz)

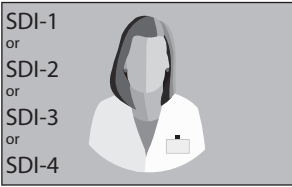

3G-SDI 2-SI

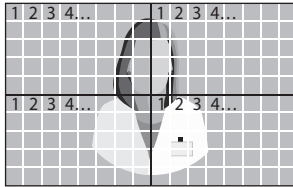

3G-SDI Quad

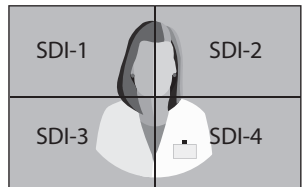

For SDI quad view setting, each connector should correspond with the four image areas as shown above.

12G-SDI Single (2160p 60Hz)

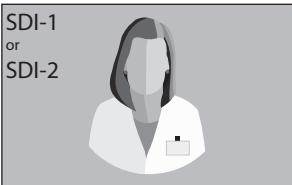

For SDI single view setting, use the INPUT menu to select which SDI source should be activated.

Standard Signal Table

Resolution	Timing Information			Signal Source			
	H-Freq (KHz)	V-Freq (Hz)	Clock (MHz)	DP	HDMI	DVI	SDI
800 x 600 @56Hz	35.16	56.25	36.00	•	•	•	
800 x 600 @60Hz	37.88	60.32	40.00	•	•	•	
800 x 600 @72Hz	48.08	72.19	50.00	•	•	•	
800 x 600 @75Hz	46.88	75.00	49.50	•	•	•	
800 x 600 @85Hz	53.67	85.06	56.25	•	•	•	
1024 x 768 @60Hz	48.36	60.00	65.00	•	•	•	
1024 x 768 @70Hz	56.48	70.07	75.00	•	•	•	
1024 x 768 @75Hz	60.02	75.03	78.75	•	•	•	
1024 x 768 @85Hz	68.68	85.00	94.50	•	•	•	
1152 x 864 @75Hz	67.50	75.00	108.00	•	•	•	
1280 x 960 @60Hz	60.00	60.00	108.00	•	•	•	
1280 x 960 @85Hz	85.94	85.00	148.50	•	•	•	
1280 x 1024 @60Hz	63.98	60.02	108.50	•	•	•	
1280 x 1024 @75Hz	79.98	75.02	135.00	•	•	•	
1280 x 1024 @85Hz	91.15	85.02	157.50	•	•	•	
720p @50Hz	37.50	50.00	74.25	•	•	•	•
720p @59.94	44.96	59.94	74.176	•	•	•	•
720p @60Hz	45.00	60.00	74.25	•	•	•	•
1080i @50Hz	28.13	50.00	74.25				•
1080i @59.94Hz	33.72	59.94	74.167				•
1080P @50Hz	56.25	50.00	148.50	•	•	•	•
1080P @59.94Hz	67.43	59.94	148.352	•	•	•	•
1080P @60Hz	67.50	60.00	148.50	•	•	•	•
1920 x 2160 @60Hz	133.29	59.99	277.25	•	•		
3840 x 2160 @30Hz	67.50	30.00	297.00	•	•		• ¹
3840x2160 @50Hz	112.50	50.00	594.00	•	•		• ²
3840 x 2160 @59.94Hz	134.87	59.94	593.407	•	•		• ²
3840 x 2160 @60Hz	135.00	60.00	594.00	•	•		• ²

Additional for FS-P3102D, FS-P3102DS, FS-P3102DG

4096 x 2160 @30Hz	67.50	30.00	297.00	•	•		
4096 x 2160 @50Hz	112.50	50.00	594.00	•	•		• ²
4096 x 2160 @59.94Hz	134.87	59.94	593.407	•	•		• ²
4096 x 2160 @60Hz	135.00	60.00	594.00	•	•		• ²

¹ Additional for FM-B2702DG, FM-E3203DG.

² SDI quadrant and 2 sample interleave division only.

Specification

FM-A2701D, FM-A2701DS

Item		Description
Panel		27 inch TFT LCD (LED)
Resolution		3840 x 2160 pixel
Aspect Ratio		16 : 9
Active Area		596.74 (H)mm x 335.66 (V)mm
Pixel Pitch (mm)		0.1554 x 0.1554
Response Time (typical)		14 ms (gray to gray)
Number of Colors		1.07 Billion
Brightness (typical)		800 cd/m ²
Gamut		BT.709 and BT.2020 compatible
Contrast Ratio (typical)		1000 : 1
Surface Treatment		Anti-glare
Viewing Angle (CR>10)		R/L 178°, U/D 178°
Input Signal		1 x HDMI 2.0 2 x DP 1.2 (SST) 1 x DVI (single link) 4 x SDI (3G) available on FM-A2701DS
Output Signal		1 x DVI (single link) 1 x DP 1.2 (SST) 4 x SDI (3G) available on FM-A2701DS
Power Supply		AC/DC Adaptor (AC 100~240V, DC 24V/6.6A)
Power Consumption		FM-A2701D 90W max FM-A2701DS 110W max
Unit Dimension		658.8(W) x 426(H) x 60(D) mm 25.94(W) x 16.77(H) x 2.36(D) inch
Package Dimension		755.65(W) x 654.05(H) x 234.95(D) mm 29.75(W) x 25.75(H) x 9.25(D) inch
IP Rating		IP31 - overall
Weight	FM-A2701D	8.18 kg, 18.03 lbs. (monitor with cover) 13.19 kg, 29.08 lbs. (shipping package)
	FM-A2701DS	8.8 kg, 19.4 lbs. (monitor with cover) 13.81 kg, 30.45 lbs. (shipping package)

Specification

FM-B2702D, FM-B2702DG

Item		Description
Panel		27 inch TFT LCD (LED)
Resolution		3840 x 2160 pixel
Aspect Ratio		16 : 9
Active Area		596.74 (H)mm x 335.66 (V)mm
Pixel Pitch (mm)		0.1554 x 0.1554
Response Time (typical)		11 ms (rise time)
Number of Colors		1.07 Billion
Brightness (typical)		800 cd/m ²
Gamut		BT.709 and BT.2020 compatible
Contrast Ratio (typical)		1400 : 1
Surface Treatment		Anti-glare
Viewing Angle (CR>10)		R/L 178°, U/D 178°
Input Signal		1 x HDMI 2.0 2 x DP 1.2 (SST) 1 x DVI (single link) 4 x SDI (3G), 2 x SDI (12G) available on FM-B2702DG
Output Signal		1 x DP 1.2 (SST) 1 x DVI (single link) 4 x SDI (3G), 2 x SDI (12G) available on FM-B2702DG
Power Supply		AC/DC Adaptor (AC 100~240V, DC 24V/6.6A)
Power Consumption		FM-B2702D 85W FM-B2702DG 100W
Unit Dimension		673(W) x 425(H) x 75.2(D) mm 26.50(W) x 16.73(H) x 2.96(D) inch
Package Dimension		755.65(W) x 654.05(H) x 234.95(D) mm 29.75(W) x 25.75(H) x 9.25(D) inch
IP Rating		IP33 - overall
Weight	FM-B2702D	8.73 kg, 19.25 lbs. (monitor with cover) 13.45 kg, 29.65 lbs. (shipping package)
	FM-B2702DG	9.2 kg, 20.28 lbs. (monitor with cover) 14.1 kg, 31.09 lbs. (shipping package)

Specification

FS-P3102D, FS-P3102DS, FS-P3102DG

Item		Description
Panel		31 inch TFT LCD (LED)
Resolution		4096 x 2160 pixel
Aspect Ratio		17 : 9
Active Area		697.958 (H)mm x 368.064 (V)mm
Pixel Pitch (mm)		0.1704 x 0.1704
Response Time (typical)		11 ms (rise time)
Number of Colors		1.07 Billion
Brightness (typical)		350 cd/m ²
Gamut		BT.709 and BT.2020 compatible
Contrast Ratio (typical)		1500 : 1
Surface Treatment		Anti-glare
Viewing Angle (CR>10)		R/L 178°, U/D 178°
Input Signal		1 x HDMI 2.0 1 x DP 1.2 (SST), 1 x DP 1.2 (MST), 2 x DP 1.2 (SST) available on FS-P3102DG 1 x DVI (single link) 4 x SDI (3G) available on FS-P3102DS 4 x SDI (3G), 2 x SDI (12G) available on FS-P3102DG
Output Signal		1 x DP 1.2 (SST) 1 x DVI (single link) 4 x SDI (3G) available on FS-P3102DS 4 x SDI (3G), 2 x SDI (12G) available on FS-P3102DG
Power Supply		AC/DC Adaptor (AC 100~240V, DC 24V/6.6A)
Power Consumption		FS-P3102D 90W FS-P3102DS, FS-P3102DG 110W
Unit Dimension		773.1(W) x 453.6(H) x 75.5(D) mm 30.44(W) x 17.86(H) x 2.97(D) inch
Package Dimension		914.4(W) x 749.3(H) x 234.95(D) mm 36(W) x 29.5(H) x 9.25(D) inch
IP Rating		IP33 - overall
Weight	FS-P3102D	10.62 kg, 23.41 lbs. (monitor with cover) 16.46 kg, 36.29 lbs. (shipping package)
	FS-P3102DS FS-P3102DG	11.24 kg, 24.78 lbs. (monitor with cover) 17.34 kg, 38.23 lbs. (shipping package)

Specification

FM-E3203D, FM-E3203DG

Item		Description
Panel		32 inch TFT LCD (LED)
Resolution		3840 x 2160 pixels
Aspect Ratio		16 : 9
Active Area		708.48 (H)mm x 398.82 (V)mm
Pixel Pitch (mm)		0.1845 x 0.1845
Response Time (typical)		8 ms (rise time)
Number of Colors		1.07 Billion
Brightness (typical)		700 cd/m ²
Gamut		BT.709 and BT.2020 compatible
Contrast Ratio (typical)		1350 : 1
Surface Treatment		Anti-glare
Viewing Angle (CR>10)		R/L 178°, U/D 178°
Input Signal		1 x HDMI 2.0 2 x DP 1.2 (SST) 1 x DVI (single link) 4 x SDI (3G), 2 x SDI (12G) available on FM-E3203DG
Output Signal		1 x DP 1.2 (SST) 1 x DVI (single link) 4 x SDI (3G), 2 x SDI (12G) available on FM-E3203DG
Power Supply		AC/DC Adaptor (AC 100~240V, DC 24V/6.6A)
Power Consumption		FM-E3203D 105W max FM-E3203DG 125W max
Unit Dimension		773(W) x 478(H) x 75.2(D) mm 30.43(W) x 18.82(H) x 2.96(D) inch
Package Dimension		914.4(W) x 749.3(H) x 234.95(D) mm 36(W) x 29.5(H) x 9.25(D) inch
IP Rating		IP33 - overall
Weight	FM-E3203D	11.56 kg, 25.49 lbs. (monitor with cover) 16.83 kg, 37.10 lbs. (shipping package)
	FM-E3203DG	11.80 kg, 26.01 lbs. (monitor with cover) 17.5 kg, 38.58 lbs. (shipping package)

Cleaning Instructions



Follow your hospital protocol for the handling of blood and body fluids. Clean the display with a diluted mixture of mild detergent and water. Use a soft cotton towel or swab. Use of certain detergents may cause degradation to the labels and plastic components of the product. Consult cleanser manufacturer to see if agent is compatible. Do not allow liquid to enter the display.

Precautions

- Take care not to damage or scratch the front filter or LCD panel.
- Do not use cloth made from synthetic material (polyester) as this may cause electrostatic discoloration within the LCD.
- Follow your hospital protocol in case the display needs to be disinfected prior to installation.

Front Filter

1. Remove dust with a dry, lint-free, non-abrasive soft cotton cloth.
2. Remove fingerprints or grease using a lint-free, non-abrasive soft cotton cloth that is lightly moistened with plain water or a mild commercial glass cleaning product suited for coated glass surfaces.
3. Gently wipe dry with a dry cotton cloth.

The following cleaning products are tested and approved:

- Misty Clear Lemon 10 Disinfectant • Bohle glass cleaner • Zep Heavy-duty glass & all surface cleaner • Klear Screen • Screen TFT (Kontakt Chemie) • Incidin Foam (Ecolab) • Microzid • Mild detergent • Isopropyl alcohol with concentration < 5% • Household bleach (generic sodium hypochlorite, solutions of 5.25% sodium hypochlorite diluted with water between 1:10 and 1:100)

Do NOT use on front filter:

- Alcohol/solvents at higher concentration > 5% • Strong alkalis, strong solvents • Acid
- Detergents with fluoride • Detergents with ammonia • Detergents with abrasives • Steel wool • Sponge with abrasives • Steel blades • Synthetic (polyester) cloth • Cloth with steel thread

Cabinet

1. Clean the cabinet using a soft cotton cloth, lightly moistened with a recognized cleaning product for medical equipment.
2. Repeat with water only.
3. Wipe dry with a dry cloth.

The cabinet has been tested for resistance to the following products:

- Virex Ready-to-use Disinfectant Cleaner • Misty Clear Lemon 10 Disinfectant • Misty Multi-Purpose Disinfectant Cleaner • Misty Multi-Purpose Disinfectant Cleaner II • Zep Heavy-duty glass & all surface cleaner • Klear Screen • Screen TFT (Kontakt Chemie) • Incidin Foam (Ecolab) • Microzid • Mild detergent • Isopropyl alcohol with concentration < 5% • Household bleach (generic sodium hypochlorite, solutions of 5.25% sodium hypochlorite diluted with water between 1:10 and 1:100) • Precise Hospital Foam Cleaner Disinfectant

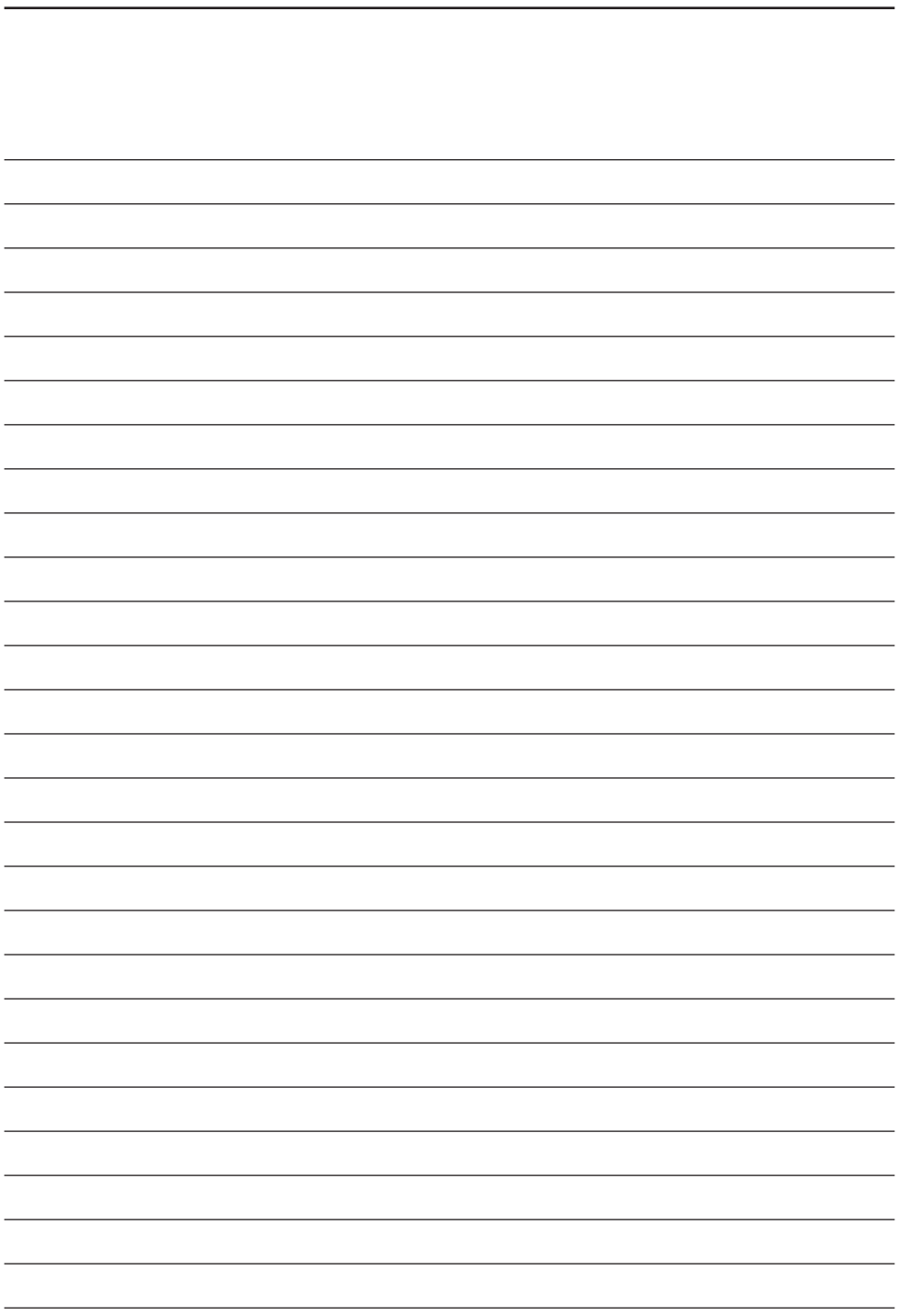

Thank you for choosing our product.

Service

Contact the appropriate customer service listed below for product information or assistance.

Warranty

One year, parts and labor.

 EC Representative

KTR Europe GmbH
Mergenthalerallee 77, Eschborn 65760, Germany
Tel : +49(0)6196-887170

 **FORESEESON GmbH**

Industriestrasse 38a, 63150 Heusenstamm, Germany
Tel. +49(0)6104-643980

 **FORESEESON UK Ltd.**

1 Wolsey Road, East Molesey
Surrey, KT8 9EL
United Kingdom
Tel. +44-(0)208-546-1047

 **FORESEESON KOREA**

404B, PangyoInnovalley B, 253 Pangyo-ro, Bundang-gu,
Seongnam-si, Gyeonggi-do, Korea, 463-400
Tel. +82(31)8018-0780 Fax. +82(31)8018-0786

 **FORESEESON (Shanghai) Medical Equipment Co., Ltd.**

Room 307, 3F No. 56, 461 Hongcao Road
Caohejing Development District
Xuhui, Shanghai 200233
Tel: 86-21-6113-4188



FSN™

FORESEESON CUSTOM DISPLAYS, INC.

2210 E. Winston Road, Anaheim, CA 92806 USA
Tel. 1-714-300-0540 Fax. 1-714-300-0546

FSN2053 4/2021 Rev. - 8/2021

Specifications are subject to change with or without notice.



www.fsnmed.com