



FSN

Image Processing System

Instructions for Use

IPS100A

Quad SDI to 12G SDI / HDMI 4K Converter

IPS500A

Universal Converter

Before connecting, operating or adjusting this product, please read this instruction booklet carefully and completely.

English

Table of Contents

Product Description / Intended Use	3
Symbol Definitions	4
Warnings, Precautions	5,6
Safety Instructions	7-9
Electromagnetic Compatibility	10-14
Cleaning Instructions	31

IPS100A

Package Contents.	14
Installation	15-16
Settings	17
Video Resolution Timing	18, 19
General Specification	20, 21

IPS500A

Package Contents.	22
Installation	22-24
Settings	24-26
Video Resolution Timing	27, 28
General Specification	29, 30

The specifications and information in this document are subject to change without notice.



Instructions for Use for this product are also available in electronic form (eIFU). Choose from several languages. Use Adobe Acrobat software to view eIFUs. Access the eIFUs online at: fsnmed.com/support/eifu/

Product Description / Intended Use



IPS100A

IPS100A is a video signal converter that accepts quad SDI (3G or 12G) input up to 4K, and delivers single SDI (3G or 12G) or HDMI 2.0 output up to 4K.

- Mode select switch configuration allows for quick setup.
- Meets medical certification requirements.
- User controls and settings are accessed through a USB interface.
- Firmware updates are fast and easy.



IPS500A

IPS500A is a universal converter that features advanced video distribution and control. It accepts a variety of video input signals and converts the signal for output as a DVI or 3G-SDI. It has capabilities for advanced windowing, video bypass, and external control.

Front panel buttons control the on-screen menus, and the built-in LCD front display shows the status of input and output signals. IPS500A can take video signals from a source that does not have digital video output, and convert the video for use with digital display devices.

Intended Purpose

This device is intended to be connected to other medical equipment. This device is not intended for diagnosis. This device is intended to be compatible with other highly specialized surgical and diagnostic equipment used in surgical suites, operating rooms, emergency rooms, and procedural facilities.

Intended Use Environment

This device is intended to be used by a trained medical professional in a healthcare facility setting where contact with a patient is unlikely (no applied part).

This device is designed to meet the medical safety requirements for a patient vicinity device.

































Warning: This device may not be used in connection with life support equipment.

Indications for Use

This device is to be used by a trained medical professional. This device connects to medical imaging equipment to display images, videos or patient information during surgical procedures. This device is not intended for diagnosis.

Symbol Definitions

The following symbols appear on the product, its labeling, or the product packing. Each symbol carries a special definition, as defined below:

	Dangerous : High Voltage		Power adapter		Consult accompanying documents
	Direct current		Indicates equipotential earth ground		Unique Device Identifier
	Indicates protective earth ground		Indicates top-bottom direction		Korea Certification
	DC Power control switch		Fragile		Approved according to the CCC regulations
	Do not get wet		Maximum Stacking		China RoHS labels
	Consult the operating instructions		Indicates the manufacturer		Catalog Number
	Indicates the manufacturing date		Authorized representative in the European community		Medical Device
	Serial Number		Humidity limitation		Consult the operating instructions - electronic
	Temperature limitation		Atmospheric pressure limitation		Importer Entity
	UK Conformity Assessed				
	Indicates proof of conformity to EU 2017/745 Medical Devices Regulation and applicable standards.				
	Medical Equipment is in accordance with ANSI/AAMI ES60601-1 (2005) + AMD 1 (2012) and CAN/CSA-C22.2 No. 60601-1 (2014) in regards to electric shock, fire hazards, and mechanical hazard.				
	Tested to comply with FCC Class B standard (USA).				
	Waste electrical and electronic equipment (WEEE Directive 2012/19/EU). This symbol indicates that the waste of electronic equipment must not be disposed as unsorted municipal waste and must be collected separately. Please contact the manufacturer or other authorized disposal company to decommission your equipment.				

Note: A printed copy of the manual in English is provided with the product. Users within EU member states, please contact local distributor for other languages. This applies to EU member states where the product has been purchased through authorized channels.

Warnings and Precautions

Caution Information



This symbol alerts the user that important literature concerning the operation of this unit has been included. Therefore, it should be read carefully in order to avoid potential problems.



This symbol warns users that un-insulated voltage within the unit may have sufficient magnitude to cause electrical shock. Therefore, it is dangerous to make contact with any part inside the unit. To reduce the risk of electrical shock, DO NOT remove cover (or back). There are no user-serviceable parts inside. Refer servicing to qualified service personnel.

To prevent fire or shock hazards, do not expose this unit to rain or moisture. Do not use this unit's polarized plug with an extension cord receptacle or other outlets unless the prongs can be fully inserted.



Underwriters Laboratories (UL) Classification:

UL safety Compliance:

This device is U.L. Classified WITH RESPECT TO ELECTRIC SHOCK, FIRE AND MECHANICAL HAZARDS ONLY IN ACCORDANCE WITH UL 60601-1/CAN/CSA C22.2 NO. 601.1



EU Conformity and EMC Compliance:

This device meets the requirements of EN60601-1 and EN60601-1-2 so as to conform to the EU Medical Devices Regulation (MDR 2017/745). CE class I medical device accessory.

This device complies to the above standards only when used with the supplied medical grade power supply. Use 120V rating 5-15P type plug only in the U.S.

IPS100A - ATM065T-P120
IPS500A - JMW190KB1200F04

Caution: Make sure the power cord is the correct type that is required in your geographic area. This device has a universal power supply that allows operation in either 100-120V AC or 200-240V AC voltage areas (no user adjustment is required).

Use the proper power cord with correct attachment plug type. If the power source is 120 V AC, use a power cord which is a Hospital Grade Power Cord with NEMA 5-15 style plug, labeled for 125 volts AC with UL and C-UL approvals. If the power source is a 240 V AC supply, use the tandem (T blade) type attachment plug with ground conductor power cord that meets the respective European country's safety regulations.



Recycling (WEEE Directive 2012/19/EU)

Follow local governing ordinances and recycling plans regarding the recycling or disposal of this equipment.

Warning: Use of this equipment adjacent to or stacked with other equipment should be avoided because it could result in improper operation. If such use is necessary, this equipment and the other equipment should be observed to verify that they are operating normally.

Warning: Use of accessories, transducers and cables other than those specified or provided by the manufacturer of this equipment could result in increased electromagnetic emissions or decreased electromagnetic immunity of this equipment and result in improper operation.

Warning: Portable RF communications equipment (including peripherals such as antenna cables and external antennas) should be used no closer than 30 cm (12 inches) to any part of this device, including cables specified by the manufacturer. Otherwise, degradation of the performance of this equipment could result.

Warning: Using this equipment in the X-ray or magnetic resonance environment could result in degradation of the performance of this equipment, interference with other equipment or interference with radio services.

Warning: The use of cables and/or other accessories with this device, other than those specified, may result in increased emissions or decreased immunity of this device.

Warning: This product is not considered physically to connect to HF (High Frequency) electrosurgical equipment.

Warning: Not suitable for use in the presence of a flammable anesthetics mixture with oxygen or with nitrous oxide.

Safety Instructions

On Safety

1. Before connecting the AC power cord to the DC adapter outlet make sure the voltage designation of the DC adapter corresponds to the local electrical supply.
2. Never insert anything metallic into the cabinet openings of the device. Doing so may create the danger of electric shock.
3. To reduce the risk of electric shock, do not remove cover. No user-serviceable parts inside. Only a qualified technician should open the case of the device.
4. Never use the device if the power cord has been damaged. Do not allow anything to rest on the power cord, and keep the cord away from areas where people can trip over it.
5. Be sure to hold the plug, not the cord, when disconnecting the device power cord from an electric socket.
6. Unplug the device power cord when it is going to be left unused for an extended period of time.
7. Unplug the device power cord from the AC outlet before any service.
8. If the device does not operate normally, in particular, if there are any unusual sounds or smells coming from it, unplug it immediately and contact an authorized dealer or service center.
9. Please contact the manufacturer if the set should be installed in an inaccessible area.

Warning: Do not touch input or output connectors and the patient simultaneously.

Warning: This device is intended for connection to input/output signals and other connectors that comply with relevant IEC standard (e.g., IEC60950 for IT equipment and IEC60601 series for medical electrical equipment). In addition, all such combination-system shall comply with the standard IEC 60601-1-1 or clause 16 of the 3 Ed. of IEC 60601-1, respectively, safety requirements for medical electrical systems. Any person who has formed a combination-system is responsible for the system to comply with the requirements of IEC 60601-1-1 or clause 16 of the 3 Ed. of IEC 60601-1, respectively. If in doubt, contact qualified technician or your local representative.

Warning: To avoid risk of electric shock, this device must only be connected to a supply mains with protective earth. Power supply (AC/DC Adapter) is specified as a part of the device. Do not position equipment in such a way that it is difficult to disconnect the power cord plug from the appliance inlet.

Warning: Do not modify this equipment without authorization of the manufacturer.

Product fuse has a lower breaking capacity. Do not install at the building power system, prospective short-circuit current exceeding 35 A.

Environmental Conditions for Operation and Storage

Temperature range within 0°C to 40°C(operation), -20°C to 60°C (storage)

Relative humidity range 10% to 85%

Atmospheric pressure range within 500 to 1060hPa.

On Installation

1. Openings in the device cabinet are provided for ventilation. To prevent overheating, these openings should not be blocked or covered. If you put the device in a bookcase or some other enclosed space, be sure to provide adequate ventilation.
2. Do not expose the device to rain or use it near water. If the device accidentally gets wet, unplug it and contact an authorized dealer immediately. You can clean the device with a damp cloth if necessary, but be sure to unplug the device first.
3. Place your device near an easily accessible AC outlet.
4. High temperature can cause problems. Max operating temperature is 40°C. Don't use your device in direct sunlight and keep it away from heaters, stoves, fireplaces, and sources of heat.
5. Always use only the original cables and accessories with the device.

Repair

Do not attempt to service the device yourself, as opening or removing covers may expose you to dangerous voltages or other hazards, and will void the warranty. Refer all servicing to qualified service personnel. Unplug the device from its power source and refer servicing to qualified personnel under the following conditions:

- If the power cord or plug is damaged or frayed.
- If liquid has been spilled into the device.
- If objects have fallen into the device.
- If the device has been exposed to rain or moisture.
- If the device has been subjected to excessive shock by being dropped.
- If the cabinet has been damaged.
- If the device seems to be overheated.
- If the device emits smoke or abnormal odor.
- If the device fails to operate in accordance with the operating instructions.

Biohazards

To prevent spreading of infections, this device should only be used in environments where biological decontamination can be successfully performed.

Returned Product

After troubleshooting, if problems persist, disinfect the device and return it to FSN using the original packaging. Include the accessories that came with the device in the return shipment. Please enclose a brief explanation of the malfunction.

Contact FSN Medical Technologies for a Return Authorization Number and instructions, prior to returning the device.

Accessories

Use only accessories specified by the manufacturer, or sold with the device.

Classification for Safety Compliance

- Protection against electric shock : Class I including AC/DC adapter. This medical equipment is in accordance with ANSI/AAMI ES60601-1 (2005) + AMD 1 (2012) and CAN/CSA-C22.2 No. 60601-1 (2014) in regards to electric shock, fire hazards, and mechanical hazard.
- Applied Parts : No Applied Parts.
- Degree of safety in the presence of flammable anesthetics mixture with air or with oxygen or with nitrous oxide. Not suitable for use in the presence of a flammable anesthetics mixture with oxygen or with nitrous oxide.
- For critical applications, it is recommended to have a replacement device available.
- Mode of operation : Continuous.

Notice to the user:

Any serious incident that has occurred in relation to the device should be reported to the manufacturer and the competent authority of the Member State in which the user and/or patient is established. Contact your local FSN Medical Technologies sales representative for information on changes and new products.

Electromagnetic Compatibility

This unit has been designed and tested to comply with IEC 60601-1-2:2014/AMD1:2020 requirements for EMC with other devices. To ensure electromagnetic compatibility (EMC), the device must be installed and operated according to the EMC information provided in this Instructions for Use.

This unit has been tested and found to comply with the limits of a Class B digital device, pursuant to Part 15 of the FCC rules. These limits are designed to provide reasonable protection against interference. This device can radiate radio frequency energy and, if not installed and used in accordance with the instructions, it may interfere with other radio communications equipment. There is no guarantee that interference will not occur in a particular installation. If this equipment is found to cause harmful interference to radio or television reception, the user is encouraged to try to correct the interference by carrying out one or more of the following measures:

1. Reorient or relocate the receiving antenna.
2. Increase the distance between the device and the subject of interference.
3. Plug the device into an outlet on a different electrical circuit than that to which the subject of interference is connected.
4. Consult the dealer or an experienced radio/TV technician for help.

NOTICES TO USER

This device complies with part 15 of the FCC Rules. Operation is subject to the following two conditions: (1) this device may not cause harmful interference, and (2) this device must accept any interference received, including interference that may cause undesired operation.

FCC WARNING

This device generates or uses radio frequency energy. Changes or modifications to this device may cause harmful interference unless the modifications are expressly approved in the instruction manual. The user could lose authority to operate this equipment if an unauthorized change or modification is made.

PRODUCT LIFETIME

The performance of this device may deteriorate over long periods of time. Periodically check that this device is operating correctly. The expected service life of the device is four years. Keep the clean clean to prolong its operational lifetime.

1. Guidance and manufacturer's declaration - electromagnetic emission

The device is intended for use in the electromagnetic environment specified below. The user of the device should make sure that the device is operated in such an environment.		
Interference emission measurements	Conformity level	Electromagnetic environment -guidance
RF emissions acc. to CISPR 11	Complies with Group 1	The characteristics of this device determined by broadcasting permit its industrial and hospital use (CISPR 11, Class A). When used in a living area (for which CISPR 11 usually requires Class B), this device may not provide adequate protection of radio services. The user must, if necessary, take remedial action such as implementation or reorientation of the device.
RF emissions acc. to CISPR 11	Complies with Class B	
Emission of harmonic oscillations acc. to IEC 61000-3-2	Complies with Class A	
Voltage fluctuations/flicker emissions acc. to IEC 61000-3-3	Complies	

2. For the use of ME devices in professional healthcare facilities. Guidance and manufacturer's declaration - electromagnetic immunity

The device is intended for use in the electromagnetic environment specified below. The user of the device should make sure that it is used in such an environment.		
Interference immunity test	IEC 60601-1-2:2014 conformity level	Electromagnetic environment-guidance
Electrostatic discharge (ESD) acc. to IEC 61000-4-2	Complies ± 2 kV, ± 4 kV, ± 6 kV, ± 8 kV contact discharge ± 2 kV, ± 4 kV, ± 8 kV, ± 15 kV air discharge	Floors should be made of wood, concrete or ceramic tile. If floors are covered with synthetic material, the relative humidity must be at least 30%
Rapid transient electric interferences/ bursts acc. to IEC 61000-4-4	Complies ± 2 kV for mains lines ± 1 kV for input/output lines	The quality of the supply voltage should correspond to that of a typical business or hospital environment.
Surge acc. to IEC 61000-4-5	Complies ± 1 kV push-pull voltage ± 2 kV common-mode voltage	The quality of the supply voltage should correspond to that of a typical business or hospital environment.
Voltage dips, short interruptions and fluctuations of the supply acc. to IEC 61000-4-11	0% U_T^* ; 0.5 cycle At 0°, 45°, 90°, 135°, 180°, 225°, 270°, 315° 0% U_T ; 1 cycle and 70% U_T ; 25/30 cycles Single phase: at 0° 0% U_T ; 250/300 cycle	Mains power quality should be that of a typical commercial or hospital environment. If the user of the device requests continued functioning even when interruptions of the power supply occur, it is recommended that the device be supplied from a power supply that is free of interruptions.
*Note: U_T is the mains alternating voltage before applying the test levels.		

**3. For the use of ME devices in professional healthcare facilities.
Test specification for ENCLOSURE PORT IMMUNITY to RF wireless communications equipment (according to IEC 60601-1-2:2014)**

The device is intended for use in the electromagnetic environment specified below. The user of the device should make sure that it is used in such an environment.						
Test frequency MHz	Band MHz	Service	Modulation	Maximum power W	Distance m	IMMUNITY TEST LEVEL V/m
385	380 to 390	TETRA 400	Pulse modulation 18 Hz	1.8	1.0	27
450	430 to 470	GMRS 460, FRS 460	FM ± 5 kHz stroke ± 1 kHz sine wave	2	1.0	28
710	704 to 787	Band 13, 17	Pulse modulation 217 Hz	0.2	1.0	9
745						
780						
810	800 to 960	GSM 800/900 TETRA 800, iDEN 820, CDMA 850, LTE Band 5	Pulse modulation 18 Hz	2	1.0	28
870						
930						
1720	1700 to 1990	GSM 1800, CDMA 1900, GSM 1900, DECT, LTE Band 1,3, 4, 25 UMTS	Pulse modulation 217 Hz	2	1.0	28
1845						
1970						
2450	2400 to 2570	Bluetooth, WLAN 802.11 b/g/n, RFID 2450, LTE Band 7	Pulse modulation 217 Hz	2	1.0	28
5240	5100 to 5800	WLAN 802.11 a/n	Pulse modulation 217 Hz	0.2	1.0	9
5500						
5785						
*Note: If necessary to achieve the IMMUNITY TEST LEVEL, the distance between the transmitting antenna and the device may be reduced to 1 m. The 1 m test distance is permitted by IEC 61000-4-3.						

4. Guidance and manufacturer’s declaration – electromagnetic immunity – for equipment and systems that are not life-supporting

The device is intended for use in the electromagnetic environment specified below. The user of the device should make sure that it is used in such an environment.			
Interference immunity tests	IEC 60601-1-2:2014 test level	Conformity level	Electromagnetic environment – guidelines
<p>Conducted RF disturbances acc. to IEC 61000-4-6</p> <p>Radiated RF disturbances according to IEC 61 000-4-3</p>	<p>3 V rms 150 kHz to < 80 MHz</p> <p>3 V/m 80 MHz to 2.5 GHz</p>	<p>3 V eff</p> <p>3 V/m</p>	<p>Portable and mobile RF communications equipment should be used no closer to any part of the device, including cables, than the recommended separation distance calculated from the equation applicable to the frequency of the transmitter.</p> <p>Recommended separation distance:</p> $d = 1.2 \sqrt{P}$ <p>Where P is the nominal power of the transmitter in watts [W] according to the information provided by the manufacturer of the transmitter and d is the recommended separation distance in meters [m].</p> <p>The field strength of stationary transmitters at all frequencies on site a should be, according to a study, less than the conformity level b.</p> $d = 1.2 \sqrt{P}$ <p>80 MHz to < 800 MHz</p> $d = 2.3 \sqrt{P}$ <p>800 MHz to 2.5 GHz</p> <p>Interference may occur in the vicinity of equipment marked with the following symbol:</p> 
<p>Note: These guidelines may not apply in all situations. The propagation of electromagnetic quantities is affected by absorptions and reflections of buildings, objects, and persons.</p>			
<p>a Field strengths from fixed transmitters, such as base stations for radio [cellular/cordless] telephones and land mobile radios, amateur radio, AM and FM radio broadcast and TV broadcast cannot be predicted theoretically with accuracy. To assess the electromagnetic environment of the stationary transmitters, a site survey should be considered. If the measured field strength in the location at which the device is used exceeds the above conformity levels, the device should be observed to verify normal operation. If unusual performance characteristics are observed, additional measures may be necessary, such as a modified orientation or a different location for the device.</p> <p>b Over the frequency range 150 kHz to 80 MHz, field strengths should be less than 3 V/m.</p>			

5. Recommended separation distances between portable and mobile RF communications equipment and the device

The device is intended for use in the electromagnetic environment in which the RF disturbances are controlled. The user of the device can help prevent electromagnetic interference by maintaining a minimum distance between portable and mobile RF communications equipment (transmitters) and the device – as a function of the output power of the communication device, as shown below.

Nominal power of transmitter [W]	Separation distanced [m] according to frequency of transmitter		
	150kHz to< 80 MHz $d = 1.2 \sqrt{P}$	80 MHz to< 800 MHz $d = 1.2 \sqrt{P}$	800 MHz to 2.5 GHz $d = 2.3 \sqrt{P}$
0.01	0.12	0.12	0.23
0.1	0.38	0.38	0.73
1	1.2	1.2	2.3
10	3.8	3.8	7.3
100	12	12	23

For transmitters rated at a maximum output power not listed above, the recommended separation distance **d** in meters (m) can be estimated using the equation applicable to the frequency of the transmitter, where **P** is the maximum output power rating of the transmitter in watts (W) according to the transmitter manufacturer.

Accessories IPS100A

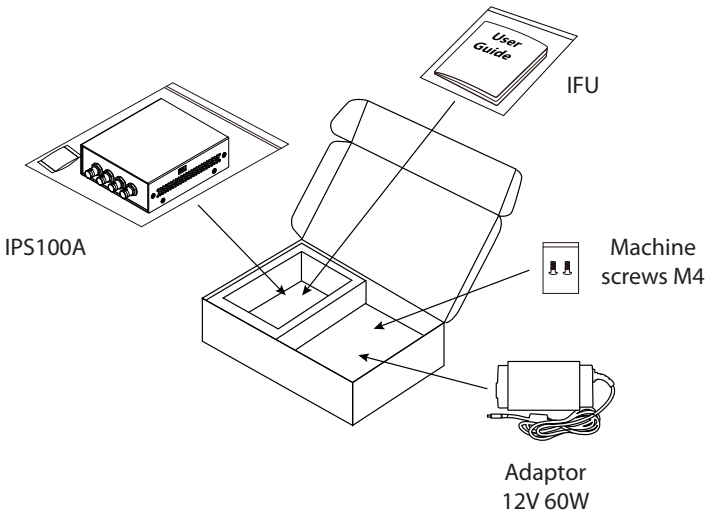

Connecting Inputs and Outputs IPS100A

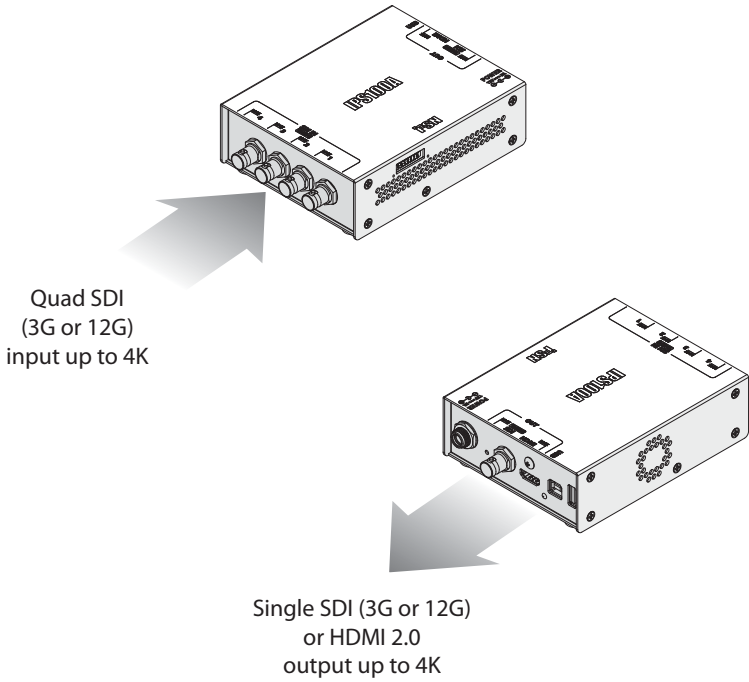

Connecting the Power Supply

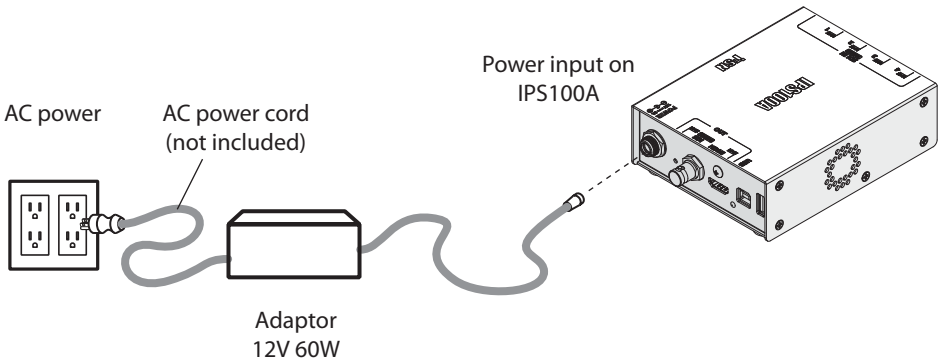

Input Output Configuration IPS100A

Input

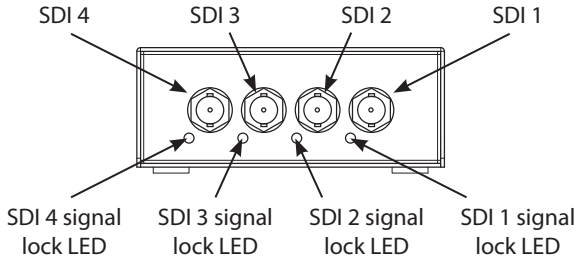

Output

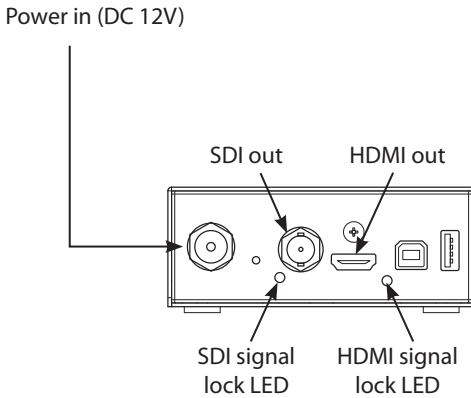

Peripheral Interface

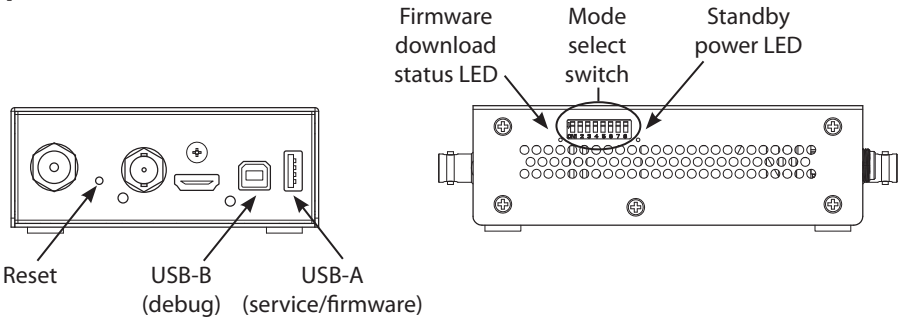

Green LED indicators will illuminate solid (lock) when a video signal is detected.

To prevent damage from overheating, IPS100A will shutdown when internal temperatures become too excessive. Both side LEDs will blink if thermal shutdown has occurred.

Settings IPS100A

Mode select switch

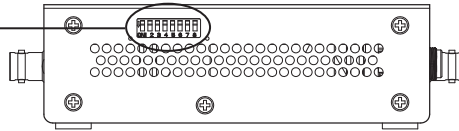

When switch 8 is off, switches 1 - 7 are active (manual control). When switch 8 is on, software/service control is active.

Switch Settings

Input Video



Quad - Square Division

(reserved)



4K Output Resolution



Auto

4K Output Format



4:2:2

Control



Manual



Quad - 2 SI



1080p



4:2:0



Software



Single - SDI 1



4K30Hz



Single - SDI 2



Single - SDI 3



Single - SDI 4

Video Format IPS100A

4K-12G	4096 x 2160p	ST2082/10, ST425-5	HD	1920 x 1080i	ST372
UHD-12G	3840 x 2160p	ST2082/10, ST425-5	HD	1280 x 720p	ST296
2K	2048 x 1080p	ST425-1	SD	720 x 576i	ST259
HD-3G	1920 x 1080p	ST425-1	SD	720 x 480i	ST259

Video Input *B = Level B-dual link.

4K-12G, UHD-12G

- 1x 12G SDI

- 4x 3Gb SDI (Level A or B-Dual Link, Two Sample Interleave (2SI) or Square Division (Quadrant))

4K	4096 x 2160p	23.98, 24, 25, 29.97, 30, 50, 59.94, 60
4K	4096 x 2160p(B)*	23.98, 24, 25, 29.97, 30
UHD	3840 x 2160p	23.98, 24, 25, 29.97, 30, 50, 59.94, 60
UHD	3840 x 2160p(B)*	23.98, 24, 25, 29.97, 30

- 4x 1.5 Gb SDI

4K	4096 x 2160p	23.98, 24, 25, 29.97, 30
4K	4096 x 2160p(B)*	23.98, 24, 25, 29.97, 30
UHD	3840 x 2160p	23.98, 24, 25, 29.97, 30
UHD	3840 x 2160p(B)*	23.98, 24, 25, 29.97, 30

2K, HD-3G

- 1x 3Gb SDI (Level A or B-Dual Link)

2K	2048 x 1080p	23.98, 24, 25, 29.97, 30, 50, 59.94, 60
2K	2048 x 1080p(B)*	23.98, 24, 25, 29.97, 30
HD	1920 x 1080p	23.98, 24, 25, 29.97, 30, 50, 59.94, 60
HD	1920 x 1080p(B)*	23.98, 24, 25, 29.97, 30
HD	1920 x 1080i	50, 59.94, 60
HD	1280 x 720p	50, 59.94, 60

HD

- 1x 1.5Gb SDI

2K	2048 x 1080p	23.98, 24, 25, 29.97, 30
2K	2048 x 1080p(B)*	23.98, 24, 25, 29.97, 30
HD	1920 x 1080p	23.98, 24, 25, 29.97, 30
HD	1920 x 1080p(B)*	23.98, 24, 25, 29.97, 30
HD	1920 x 1080i	50, 59.94, 60
HD	1280 x 720p	50, 59.94, 60

SD

- 1x 270Mb SDI

SD	625i	50
SD	525i	59.94

Video Output IPS100A

HDMI (Type A connector)

- 1x HDMI , YUV and RGB, 4:2:2 And 4:4:4 (HDMI V2.0)

4K	4096 x 2160p	23.98, 24, 25, 29.97, 30, 50, 59.94, 60
UHD	3840 x 2160p	23.98, 24, 25, 29.97, 30, 50, 59.94, 60
4K	4096 x 2160p	23.98, 24, 25, 29.97, 30
2K	2048 x 1080p	23.98, 24, 25, 29.97, 30, 50, 59.94, 60
HD	1920 x 1080p	23.98, 24, 25, 29.97, 30, 50, 59.94, 60
HD	1920 x 1080i	50, 59.94, 60
HD	1280 x 720p	50, 59.94, 60

SDI (BNC connector)

- 1x SDI, YUV and RGB, 4:2:2 And 4:4:4

4K	4096 x 2160p	23.98, 24, 25, 29.97, 30, 50, 59.94, 60
UHD	3840 x 2160p	23.98, 24, 25, 29.97, 30, 50, 59.94, 60
4K	4096 x 2160p	23.98, 24, 25, 29.97, 30
2K	2048 x 1080p	23.98, 24, 25, 29.97, 30, 50, 59.94, 60
HD	1920 x 1080p	23.98, 24, 25, 29.97, 30, 50, 59.94, 60
HD	1920 x 1080i	50, 59.94, 60
HD	1280 x 720p	50, 59.94, 60
SD	625i	50
SD	525i	59.94

Dimensions IPS100A

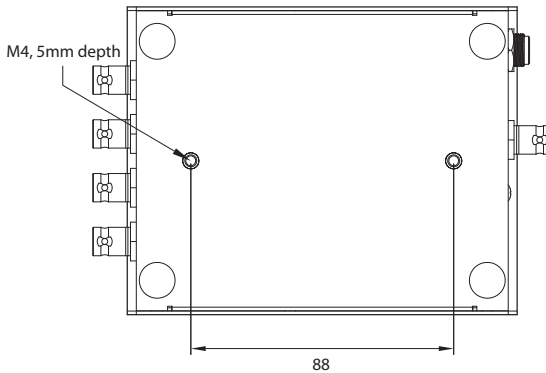
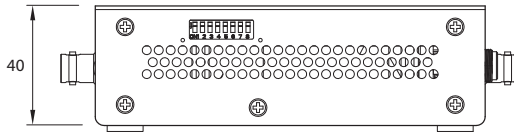
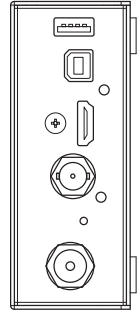
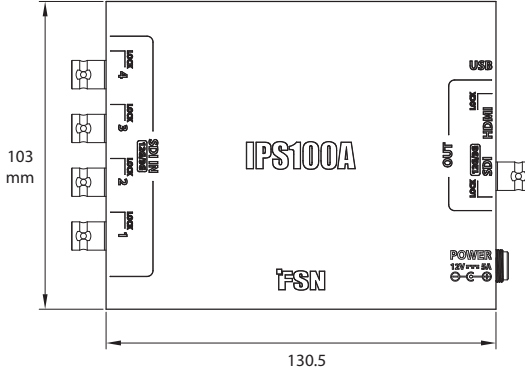
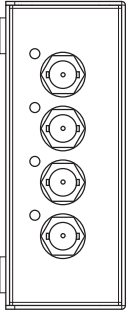
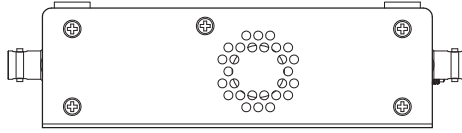

Specification IPS100A

Item	Description
Model	IPS100A
Input Signal	4 x SDI (SD/HD/3G/12G)
Output Signal	1 x HDMI (2.0) 1 x SDI (HD/3G/12G)
External Control	USB (2.0)
Power Supply	12Vdc
Power Consumption	20W max
Mode Select	Manual control: switch 8 is off, switches 1 - 7 are active. Software/service control: switch 8 is on, switches 1 - 7 are inactive, USB A and B are active.
Unit Dimension	130.5(W) x 103(H) x 40(D) mm 5.13(W) x 4.05(H) x 1.57(D) inch
Package Dimension	242(W) x 187(H) x 72(D) mm 9.53(W) x 7.36(H) x 2.83(D) inch
Weight	0.48Kg, 1.06 lbs. (IPS100A) 1.01Kg, 2.23 lbs. (shipping package)

Power Supply

Item	Description
Adapter	ATM065T-P120
Voltage and Current	+12Vdc at 5A
Cord and Length	Black UL1185 ,16AWG, 761KS12 Connector, 2000mm
Dimension	119(L) x 60(W) x 36(H), mm

Accessories IPS500A



Instructions for Use

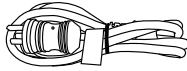

AC power cord
(6 ft., medical grade)

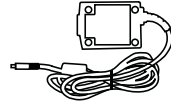

Medical AC power adaptor
JMW190KB1200F04, 12V/7A

Controls IPS500A

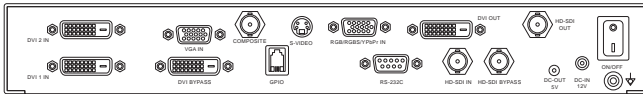
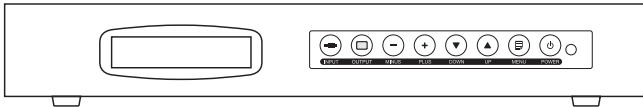

The 8 button keypad located on the front panel, allows the user to make adjustments to various display parameters.

Key Name	Description
Power	Soft power Turns the system ON/OFF.
Menu	- With OSD deactivated, Activated to OSD menu. - With OSD activated, Exit from main menu or sub menu.
UP (▲)	- With OSD deactivated, Hot key for increasing brightness. - With OSD activated, moves the OSD cursor upward.
Down (▼)	- With OSD deactivated, Hot key for decreasing brightness. - With OSD activated, moves the OSD cursor downward.
Plus (+)	- With OSD deactivated, Hot key for increasing contrast. - With OSD activated, enter sub menu and increases the adjustment of the selected function.
Minus (-)	- With OSD deactivated, Hot key for decreasing contrast. - With OSD activated, decreases the adjustment of the selected function.
Output	Changes the output timing mode.
Input	Change the display signal source. Select DVI DIGITAL2 / DVI DIGITAL1 / VGA / SDI / YPbPr, RGBS / SVIDEO / CVIDEO - With OSD deactivated, Hot key for auto adjustment when pressed for over 1 second at VGA source.

Connecting Inputs and Outputs IPS500A

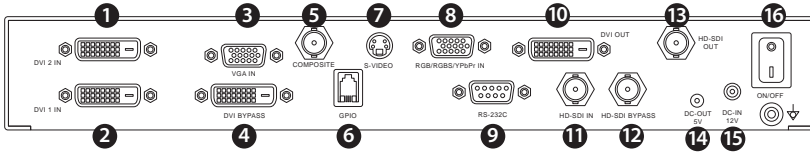

	Name	Specification
1	DVI 2 input	24P DVI-D
2	DVI 1 input	24P DVI-D
3	VGA input	15P DSUB
4	DVI 1 loop through out	24P DVI-D
5	C-VIDEO input	BNC
6	GPIO control	RJ9
7	S-VIDEO input	DIN
8	RGB(SOG)/RGBS/YPbPr input	15P DSUB
9	RS232C	9P DSUB
10	DVI output	24P DVI-D
11	3G-SDI input	BNC
12	3G-SDI loop through out	BNC
13	3G-SDI OUT	BNC
14	DC out (5V/2A)	1.7pie 2P
15	DC in (12V/7A)	1.25pie 2p
16	DC ON/OFF SWITCH	S/W
17	Ground	Terminal

Connecting the Power Supply

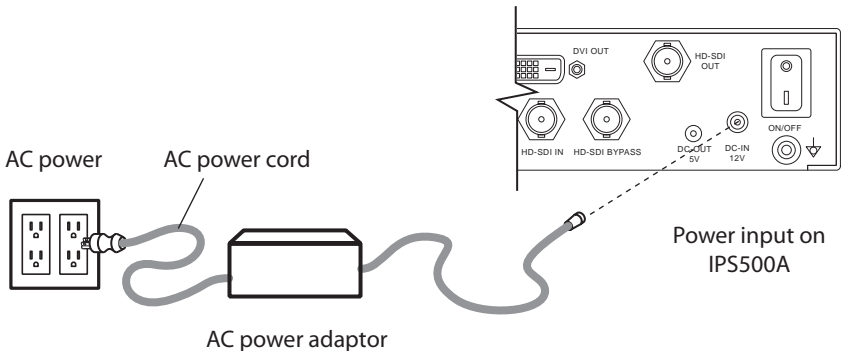

Input Output Configuration IPS500A

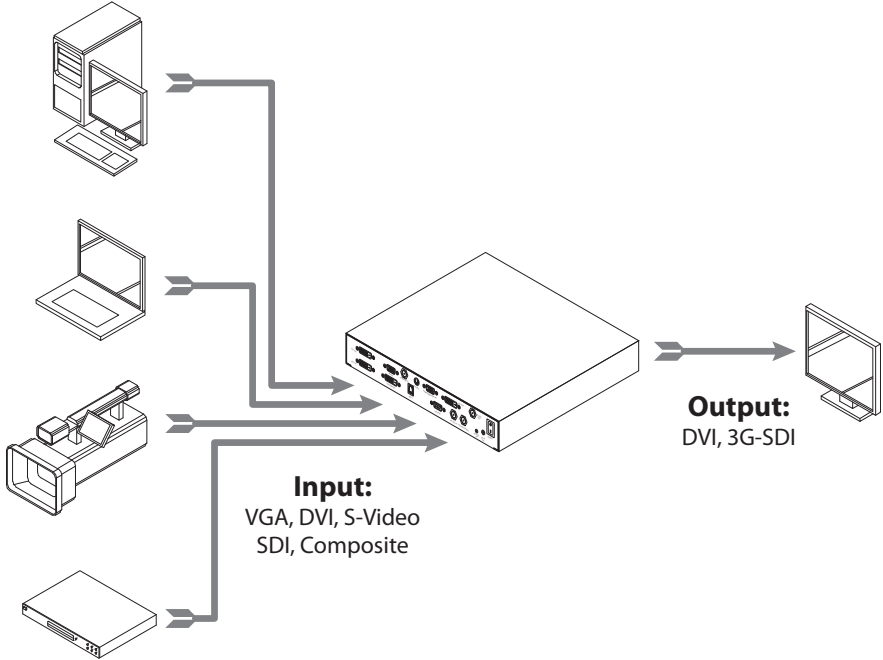

Using the LCD Display Screen

The LCD screen located on the front panel, allows the user to see input and output video signal types.



Selecting the Input Source

Repeated selecting of the INPUT button on the OSD will scroll through the input source modes.



Depending on the application, there may be more than one incoming signal type. Select the desired incoming signal type for processing.

Selecting the Output Timing

Repeated selecting of the OUTPUT button will scroll through the available timing modes. Note: SDI output cannot support SVGA, UXGA, or WUXGA timing.



Example of the LCD Display Screen

On Screen Display (OSD) IPS500A



Submenus under the ADJUST menu (variable by signal type)

1. BRIGHTNESS Increases or decreases the brightness. (Range : 0~100)
2. CONTRAST Increases or decreases the contrast. (Range : 0~100)
3. SHARPNESS Sets the sharpness of image. (Range : 0~100)
4. SATURATION Changes the tone of color. (Range : 0~100)
5. COLOR Changes the richness of color. (Range : green 0~50, red 0~50)
6. CLOCK Increases or decreases the sampling frequency. (Range : 0~100)
7. PHASE Increases or decreases the phase level. (Range : 0~100)
8. AUTO ADJUST fits to the most appropriate screen on the D-SUB Analog / RGBs signal.



Submenus under the IMAGE menu (variable by signal type)

1. IMAGE SIZE Changes the image size. (FILL ASPECT, 1:1, FILL H, FILL V, FILL ALL)
2. H POSITION Adjusts the horizontal position of the displayed source image. (Range : 0~100)
3. V POSITION Adjusts the vertical position of the displayed source image. (Range : 0~100)
4. FILTER Sets the sharpness of image. (Softest, Soft, Normal, Sharp, Sharpest)
5. OVER SCAN Adjusts the displayed size. (0~8)



Submenus under the SETUP menu

1. LANGUAGE Changes the OSD language. (8 languages)
2. OSD POSITION Changes the OSD position. (9 Positions)
3. RESET SETTINGS Changes all the OSD values to factory default.
4. AUTO SOURCE SELECT Disables or enables auto source select. (ON: Searches through all possible input sources until an active video source is found. OFF: Video input is manually selected.)
5. INACTIVE INPUT Changes the input source between RGBs and YpbPr.
6. BLANK PATTERN Enables or disables a blank pattern if no signal.
7. NO SIGNAL OSD Adjusts time until the OSD menu will disappear after DPMS by adjusting the menu. (Never, 10, 30, 60, 300 seconds). BLANK PATTERN must be disabled.



Submenus under the PIP menu

1. LAYOUT Changes the layout. (OFF, PIP, PBP1, PBP2)
2. SOURCE Changes the secondary source.
3. SIZE Changes the PIP size. (Small, Large)
4. POSITION Changes the PIP position.
5. SWAP Swaps the position of the Primary and Secondary images.

Windowing Features IPS500A

The Universal Converter offers several options for displaying picture-in-picture (PIP) or picture-by-picture (PBP) layouts on a destination source.

There are 4 basic layout to choose from.

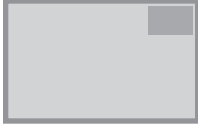

PIP (smaller inset screen - 25%)

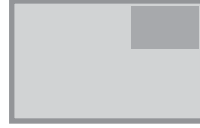

PIP (larger inset screen - 33%)



PBP1 (side-by-side screens)



PBP2 (side-by-side screens, full screen)

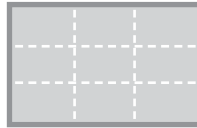

There are 9 picture-in-picture positions available.

All windowing settings are controlled through the OSD menus and submenus. A secondary source must be available for windowing to operate. A swap function changes the position of the primary and secondary images.

Not all video signal types are compatible with each other for windowing. The chart below identified the limitations between various video signal formats.

		Secondary Image							
Main Image	Input Source	DVI Digital 2	DVI Digital 1	VGA	SDI	YPbPr	RGBS	C-Video	S-Video
	DVI Digital 2	X	O	O	O	O	O	O	O
	DVI Digital 1	O	X	X	O	X	X	O	O
	VGA	O	X	X	O ¹	X	X	O	O
	SDI	O	O	O ¹	X	O ¹	O ¹	X	X
	YPbPr	O	X	X	O ¹	X	X	O	O
	RGBS	O	X	X	O ¹	X	X	O	O
	C-Video	O	O	O	X	O	O	X	X
	S-Video	O	O	O	X	O	O	X	X

X=Not Compatible O=Compatible O¹=Compatible up to UXGA, 60Hz (162 MHz)

Input / Output Timing IPS500A

VGA / DVI (Fiber DVI) in / DVI loop through out

Resolution	Horizontal Frequency (KHz)	Vertical Frequency (Hz)	Clock Frequency (MHz)
640 x 350 @70Hz	31.469	70.087	25.175
640 x 350 @85Hz	37.860	85.080	31.500
640 x 400 @60Hz	31.469	59.941	25.175
640 x 400 @70Hz	31.469	70.087	25.175
640 x 400 @85Hz	37.860	85.080	31.500
640 x 480 @60Hz	31.469	59.940	25.175
640 x 480 @72Hz	37.861	72.809	31.500
640 x 480 @75Hz	37.500	75.000	31.500
640 x 480 @85Hz	43.269	85.008	36.000
720 x 400 @85Hz	37.927	85.038	35.500
800 x 600 @56Hz	35.156	56.250	36.000
800 x 600 @60Hz	37.879	60.317	40.000
800 x 600 @72Hz	48.077	72.188	50.000
800 x 600 @75Hz	46.875	75.000	49.500
800 x 600 @85Hz	53.674	85.061	56.250
1024 x 768 @60Hz	48.363	60.004	65.000
1024 x 768 @70Hz	56.476	70.069	75.000
1024 x 768 @75Hz	60.023	75.029	78.750
1024 x 768 @85Hz	68.677	84.997	94.500
1152 x 864 @60Hz	54.348	60.053	80.000
1152 x 864 @70Hz	63.955	70.016	94.200
1152 x 864 @75Hz	67.500	75.000	108.000
1280 x 720 @60Hz	45.000	60.000	74.250
1280 x 960 @60Hz	60.000	60.000	108.000
1280 x 960 @85Hz	85.938	85.002	148.500
1280 x 1024 @60Hz	63.974	60.013	108.500
1280 x 1024 @75Hz	79.976	75.025	135.000
1280 x 1024 @85Hz	91.146	85.024	157.500
1600 x 1200 @60Hz *	74.077	59.981	130.375
1600 x 1200 @60Hz	75.000	60.000	162.000
1920 x 1080 @60Hz	67.500	60.000	148.500
1920 x 1200 @ 60Hz	73.800	59.780	154.125

* Preferred Timing for 1600 x 1200 @60Hz input

Input / Output Timing IPS500A

SDI in / SDI loop through out

Resolution	Resolution	Resolution	Resolution
480i@60	576i@50	720p@23	720p@24
720p@25	720p@50	720p@60	1080i@23
1080i@24	1080i@30	1080i@50	1080i@60
1080p@23	1080p@24	1080p@30	1080p@50
1080p@60			

DVI out

Resolution	Horizontal Frequency (KHz)	Vertical Frequency (Hz)	Clock Frequency (MHz)
1280 x 1024 @60Hz	63.800	60.000	108.000
1600 x 1200 @60Hz	75.000	60.000	162.000
1280 x 720 @60Hz	45.000	60.000	74.200
1920 x 1080 @30Hz	33.700	30.000	74.250
1920 x 1080 @60Hz	67.500	60.000	148.500
1920 x 1200 @60Hz	74.099	60.000	154.125

DVI out

Resolution	Resolution	Resolution	Resolution
720p@60	1080p@30	1080p@60	

Dimensions IPS500A

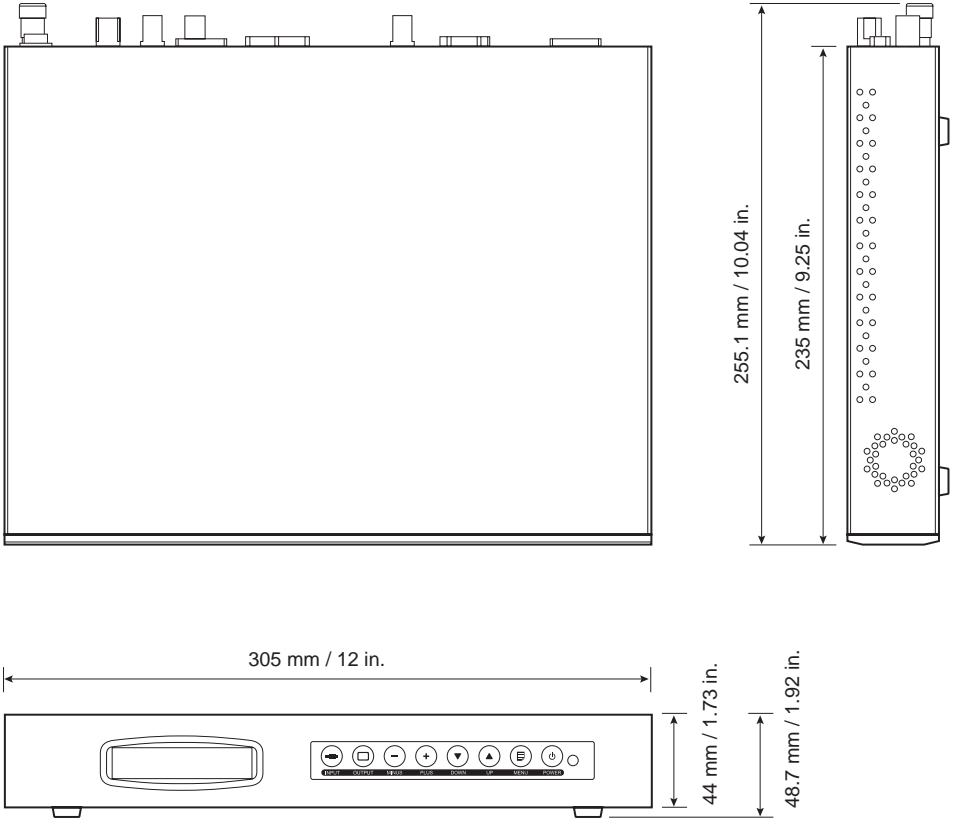

Specification IPS500A

Item	Description
Model	IPS500A
Input Signal	1 x DVI-D 1 x DVI-D (Fiber DVI detachable) 2 x D-SUB(VGA, Component, RGBs) 1x BNC (3G-SDI) 1 x BNC (CVBS) 1 x DIN (SVHS)
Output Signal	1 x DVI-D 1 x BNC (3G-SDI)
Power Supply	AC/DC Adaptor (AC 100~240V, DC 12V 7A)
Power Consumption	30W
Unit Dimension	305(W) x 51.4(H) x 255.1(D) mm 12(W) x 2(H) x 10(D) inch
Package Dimension	393.7(W) x 355.6(H) x 215.9(D) mm 15.5(W) x 14(H) x 8.5(D) inch
Weight	1.4 Kg, 3.09 lbs. (IPS500A) 4.0 Kg, 8.8 lbs. (shipping package)

Cleaning Instructions



Follow your hospital protocol for the handling of blood and body fluids. Clean the device with a diluted mixture of mild detergent and water. Use a soft cotton towel or swab. Use of certain detergents may cause degradation to the labels and plastic components of the product. Consult cleanser manufacturer to see if agent is compatible. Do not allow liquid to enter the device.

1. Clean the cabinet using a soft cotton cloth, lightly moistened with a recognized cleaning product for medical equipment.
2. Repeat with water only.
3. Wipe dry with a dry cloth.

The cabinet has been tested for resistance to the following products:

- Virex Ready-to-use Disinfectant Cleaner
- Misty Clear Lemon 10 Disinfectant
- Misty Multi-Purpose Disinfectant Cleaner
- Misty Multi-Purpose Disinfectant Cleaner II
- Zep Heavy-duty glass & all surface cleaner
- Klear Screen
- Screen TFT (Kontakt Chemie)
- Incidin Foam (Ecolab)
- Microzid
- Mild detergent
- Isopropyl alcohol with concentration < 5%
- Household bleach (generic sodium hypochlorite, solutions of 5.25% sodium hypochlorite diluted with water between 1:10 and 1:100)
- Precise Hospital Foam Cleaner Disinfectant

Thank you for choosing our product.

Service

Contact the appropriate customer service listed below for product information or assistance.

Warranty

One year, parts and labor.

 EC Representative

KTR Europe GmbH
Mergenthalerallee 77, Eschborn 65760, Germany
Tel : +49(0)6196-887170

 **FORESEESON GmbH**

Industriestrasse 38a, 63150 Heusenstamm, Germany
Tel. +49(0)6104-643980

 **FORESEESON UK Ltd.**

1 Wolsey Road, East Molesey
Surrey, KT8 9EL
United Kingdom
Tel. +44-(0)208-546-1047

 **FORESEESON KOREA**

404B, PangyoInnovalley B, 253 Pangyo-ro, Bundang-gu,
Seongnam-si, Gyeonggi-do, Korea, 463-400
Tel. +82(31)8018-0780 Fax. +82(31)8018-0786

 **FORESEESON (Shanghai) Medical Equipment Co., Ltd.**

Room 307, 3F No. 56, 461 Hongcao Road
Caohejing Development District
Xuhui, Shanghai 200233
Tel: 86-21-6113-4188



FSN™

FORESEESON CUSTOM DISPLAYS, INC.

2210 E. Winston Road, Anaheim, CA 92806 USA
Tel. 1-714-300-0540 Fax. 1-714-300-0546

FSN2055 9/2021 Rev. - 3/2022

Specifications are subject to change with or without notice.



www.fsnmed.com