

Medical Monitors

Image Processing Systems



FSN
Medical Technologies

Sharing
Your
Vision

Medical Monitors

FSN monitors for the surgical environment are highly specialized devices. They are designed and constructed to withstand the rigors of daily use in busy facilities, and have the sophistication



to work with camera systems encountered in the OR space. FSN's large installation base is a sign of quality and reliability that medical professionals have come to expect and rely upon.

FSN Monitor Innovations



3840 x 2160 resolution

4K Ultra High Definition (UHD) is four times the resolution of Full HD (1920 x 1080) pixels. When paired with a 4K UHD camera or other video source, images are sharper and more detailed.



1920 x 1080 resolution

Full High Definition (FHD) resolution is 1920 x 1080 pixels. A monitor's intended use is an important factor when choosing a resolution. FHD may be ideal for systems that do not support higher pixel counts.



High Dynamic Range

With HDR, more data is used to describe more steps in between light and dark areas in an image. Blacks and whites reach further extremes, improving the overall picture. Additionally, HDR offers a wider color gamut.



Mini LED

Targeted backlighting control (precise dimming zones) allows for images to be brighter and contrasts to be stronger. There is less backlight bleed with mini-LEDs, and better energy efficiency.



OLED

Monitor backlighting with OLED provides true blacks, increased contrast, power efficiency, and lighter weight. An OLED monitor can individually control its pixels and completely turn off itself when required.



Video over Internet Protocol

Monitors with VoIP technology utilize a method of transporting and controlling video, audio, and additional content such as timecodes and closed captioning over local or wide area networks.



Touchscreen

When a keyboard and mouse will not allow for intuitive, rapid, or accurate interaction by the medical user, touchscreens are an alternate way to engage with the monitor's content.



3D

3D visualization allows medical professionals to see spatial relationships and more life-like depth perception during a procedure. The monitor interface controls provide a selection menu for the best 3D format.



12G SDI

Advantages of 12G SDI for transmitting video and audio include: longer cable lengths, compatibility with optical fiber, uncompressed AV, no HDCP, and embedded time-code support.



Safety Bumpers

Protective guards on the bezel corners, or around the entire perimeter of the monitor, help reduce bumping injuries, especially in today's active operating room environments.

32 inch

FM-E3250D

FM-E3250DG (SDI)

FM-E3250DN (10G SFP+)



- Mini LED local dimming (2,304 dimming zones)
- 3840 x 2160 resolution
- White luminance 1000 cd/m² (full screen)
1800 cd/m² (10% center patch)
- HDR (PQ, HLG) support, dynamic contrast ratio up to 1,000,000:1
- Default 12G-SDI clone out
- Options for 12G-SDI and VoIP via 10G SFP+ (fiber and copper)

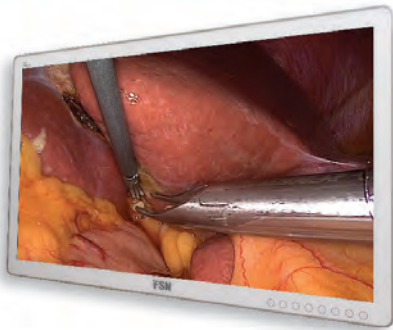

Video over IP
10G SFP+

Available on
FM-E3250DG

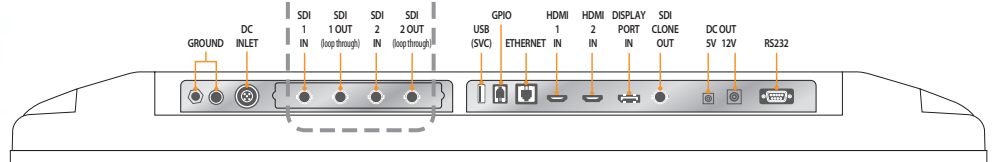

Available on
FM-E3250DN

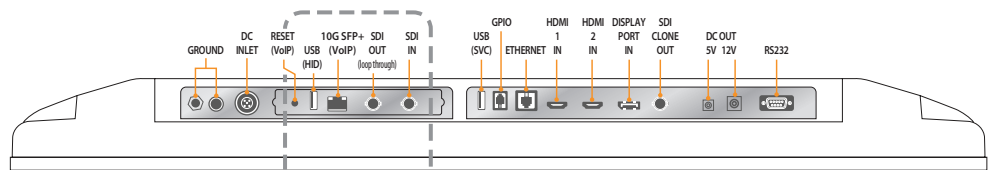

Mini LED
+
Local Dimming
+
HDR Content

Accurate
Picture Quality

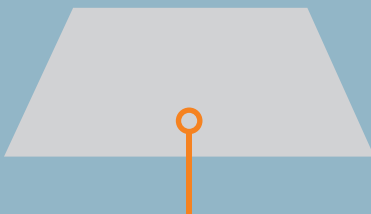
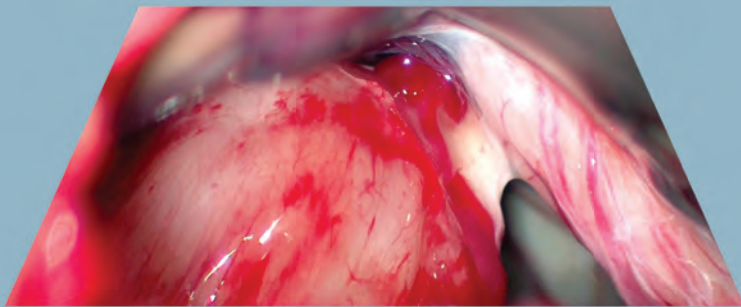

A traditional LCD backlight, illuminating the liquid crystals from behind with the same intensity across the entire screen, can have trouble with contrast.

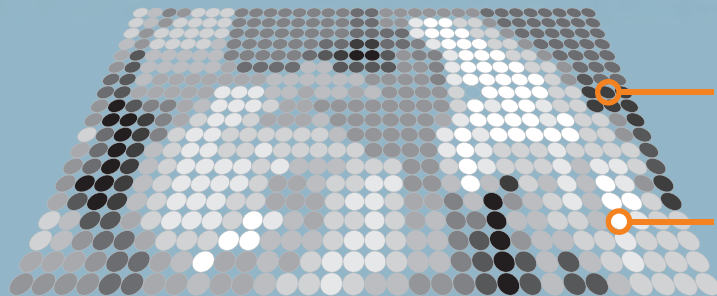

Mini LED dimmed for dark areas.

Mini LED bright for light areas.

Backlight technology implementing Mini LED with Local Dimming allows for precise control of individual zones to dynamically adjust brightness based on the image content. Results are significantly improved contrast, deeper blacks and brighter highlights compared to traditional LED backlights, particularly when displaying HDR content.

32 inch
FM-E3230D
FM-E3230DG (SDI)
FM-E3230DN (10G SFP+)



- High Dynamic Range support
- 3840 x 2160 resolution
- Brightness (typical) 850 cd/m²
- Contrast Ratio (typical) 1500:1
- Web-based network control system

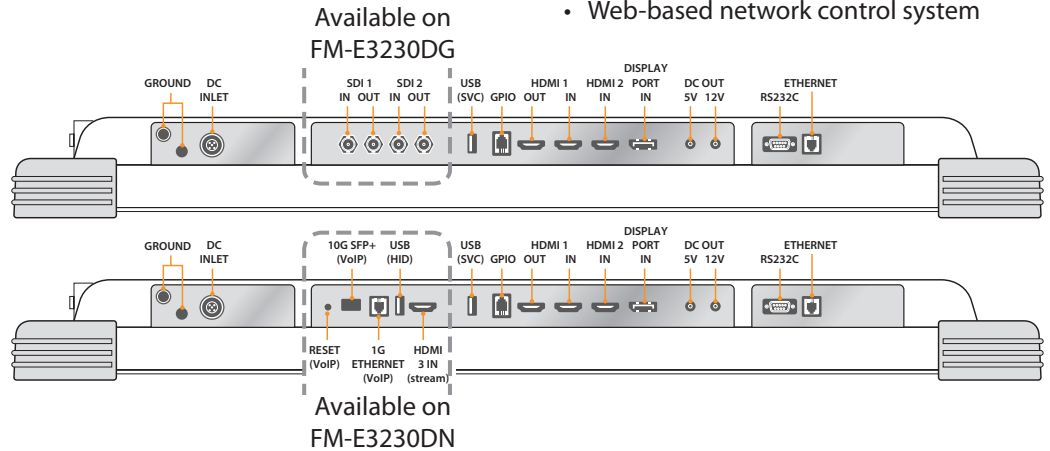

HDR (High Dynamic Range) utilizes more data to describe more steps in between light and dark areas. Very bright objects and very dark objects appear simultaneously on the same screen. With HDR, images can get brighter, darker, and show a higher number of gray tones, with blacks and whites reaching further extremes. HDR offers a wide color gamut, typically larger than standard color values used in Rec.709. FSN monitors supporting HDR will activate the technology under the Color menu and Gamma sub-menu.

Standard Dynamic Range (SDR)



High Dynamic Range (HDR)

31.5 inch
FM-F3101D
FM-F3101DG (SDI)



- OLED for high contrast, perfect blacks
- 3840 x 2160 resolution
- Brightness (typical) 540 cd/m²
- Contrast Ratio (typical) 1,000,000:1
- Multi-channel window (2, 3, 4) layouts

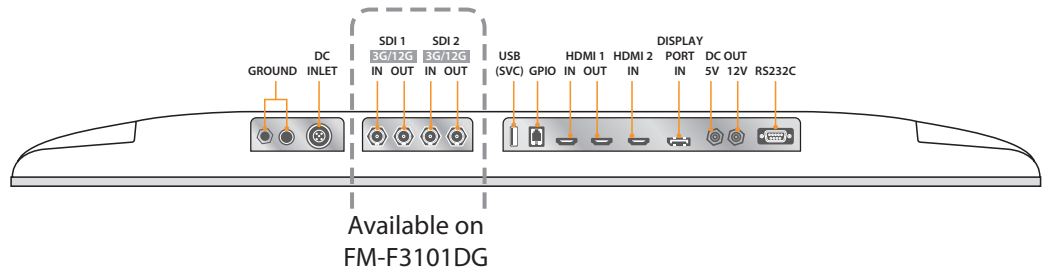

OLED offers the advantages of better picture quality, faster response time, thinner and lighter construction, and energy efficiency.

27 inch
FM-F2701D
FM-F2701DG (SDI)



- OLED for high contrast, perfect blacks
- 3840 x 2160 resolution
- Brightness (typical) 540 cd/m²
- Contrast Ratio (typical) 1,000,000:1
- Multi-channel window (2, 3, 4) layouts

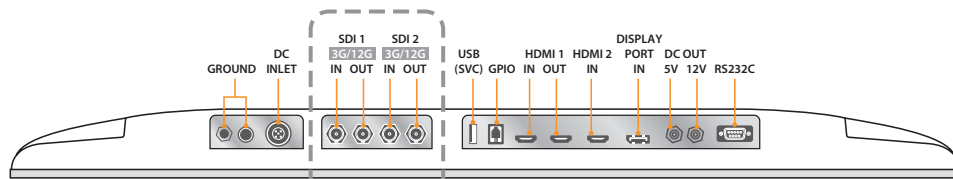

Available on
 FM-F2701DG

FSN monitors will show multi-channel windows on one screen.



Picture In Picture
 Show two video sources.
 Adjust inset picture location.



Picture By Picture
 Show two video sources.
 Three layout modes.

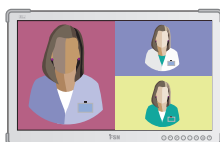

Triple
 Show three video sources.
 Four layout modes.

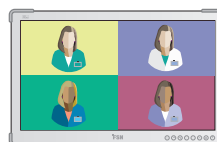

Quad
 Show four video sources.
 Five layout modes.



FSN monitors are designed for cart, wall, or boom arm mounting.

27 inch
FM-E2701D
FM-E2701DG (SDI)



- 3840 x 2160 resolution
- Brightness (typical) 700 cd/m²
- Contrast Ratio (typical) 1000:1
- Image rotate and mirror

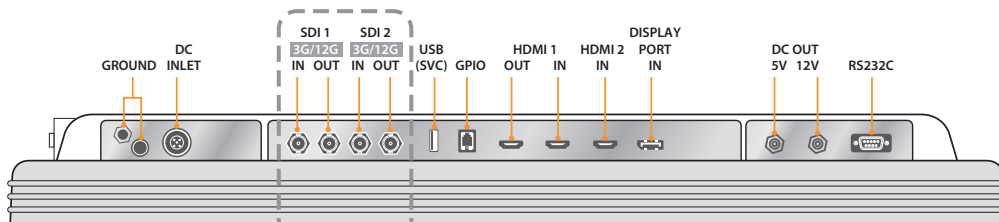

Available on
 FM-E2701DG

55 inch
FM-C5501DV



Energy efficient edge-LED design. Eco-friendly material composition certified by RoHS.

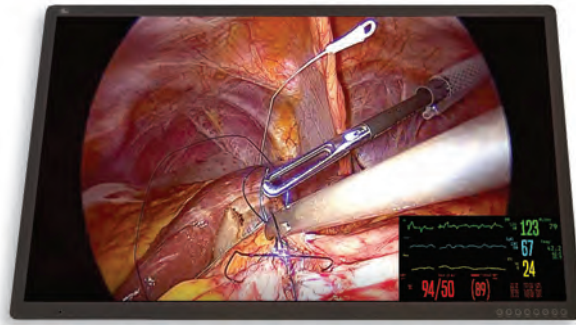

- DVI dual link
- 3840 x 2160 resolution
- Brightness (typical) 500 cd/m²
- Contrast Ratio (typical) 4,000:1

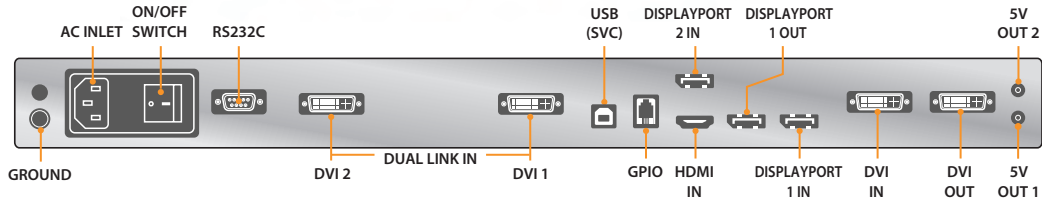

55 inch
FM-A5504DS
FM-A5504DG



Choose from PIP, PBP, Triple, or Quad layouts that are preset and ready-to-go in the on-screen display menus.



- Multi window (2, 3, 4) layouts
- 3840 x 2160 resolution
- Brightness (typical) 500 cd/m²
- Contrast Ratio (typical) 1100:1

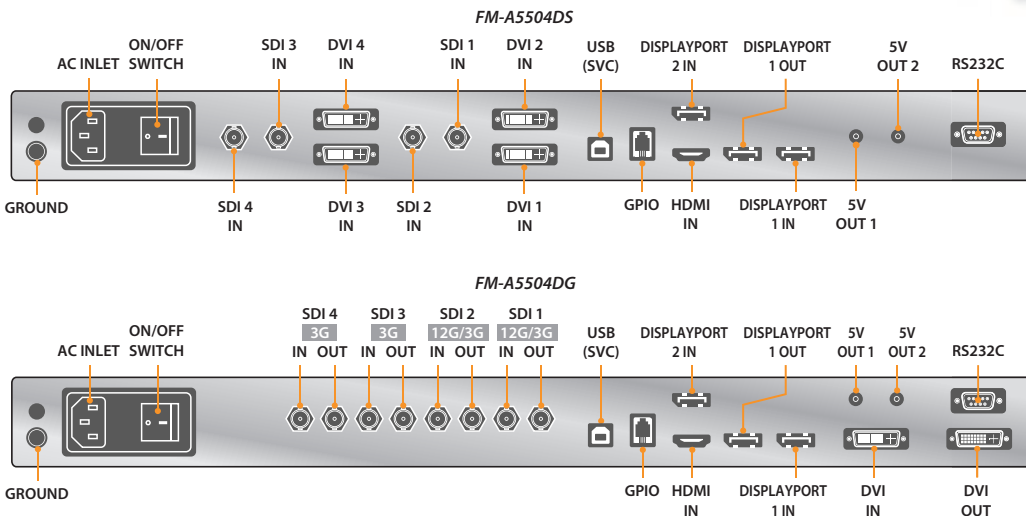

FSN large monitors will integrate with a cart, boom, or fixed wall mounting.

58 inch
FM-D5802DV

- DICOM mode, multi-modality imaging
- Luminance stability - backlight sensor
- 3840 x 2160 resolution
- Brightness (typical) 700 cd/m²
- Contrast Ratio (typical) 4000 :1

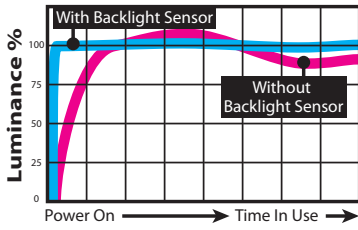

With luminance stability, uniform brightness is held constant across the entire screen surface.

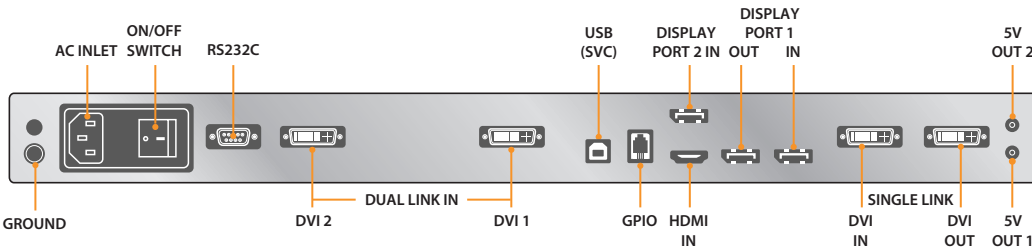
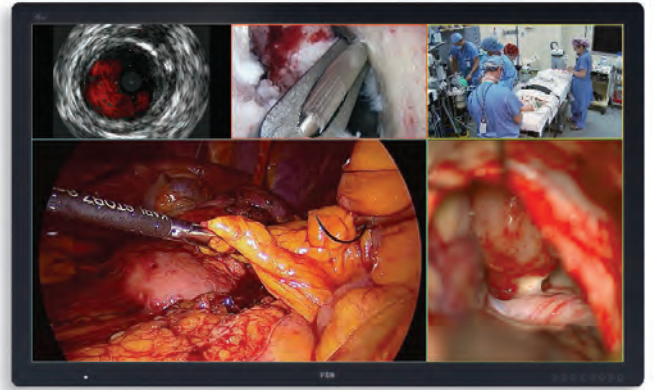

Multi-modality imaging



27 inch
FS-A2702DST

- 10 point projected capacitive touch
- Multi-channel window (2, 3, 4) layouts
- 1920 x 1080 resolution
- Brightness (typical) 700 cd/m²
- Contrast Ratio (typical) 1000:1

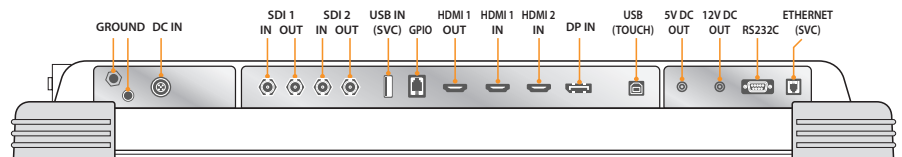

21 inch
FS-E2102DT



- 10 point projected capacitive touch
- Single, PIP, PBP, triple window layouts
- 1920 x 1080 resolution
- Brightness (typical) 300 cd/m²
- Contrast Ratio (typical) 1000:1

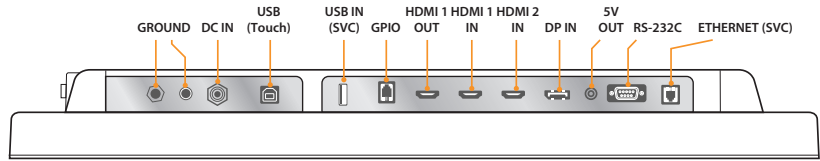

21 inch
FS-E2102D



- Small form, lightweight design
- Single, PIP, PBP, triple window layouts
- 1920 x 1080 resolution
- Brightness (typical) 350 cd/m²
- Contrast Ratio (typical) 1000:1

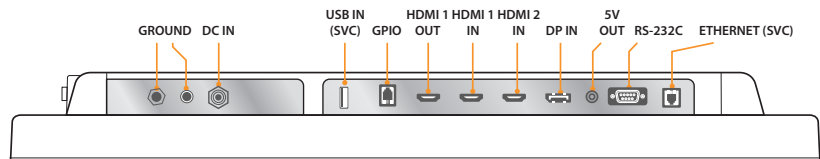

27 inch
FS-A2702DS



- Multi-channel window (2, 3, 4) layouts
- 1920 x 1080 resolution
- Brightness (typical) 800 cd/m²
- Contrast Ratio (typical) 1000:1

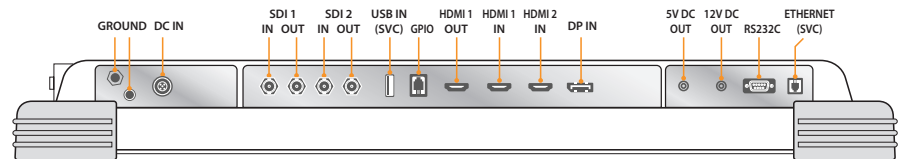

32 inch
FS-A3202DS



- Multi-channel window (2, 3, 4) layouts
- 1920 x 1080 resolution
- Brightness (typical) 500 cd/m²
- Contrast Ratio (typical) 1300:1

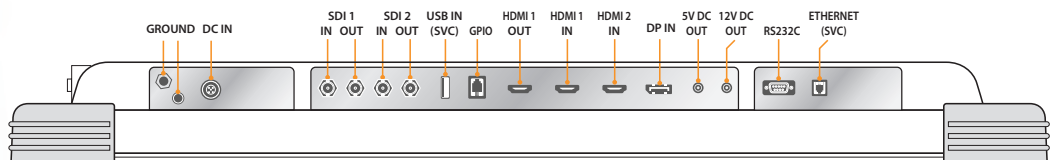

32 inch
FM-E3204DGC (Rev.01)



- Enable and select the best 3D format
- 3840 x 2160 resolution
- Brightness (typical) 500 cd/m² (2D)
- Contrast Ratio (typical) 1250:1 (2D)
- Fast detection of MIS camera systems

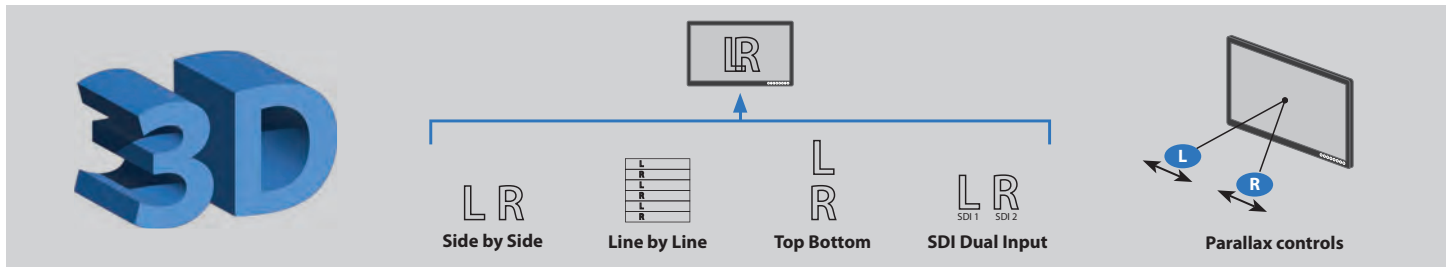
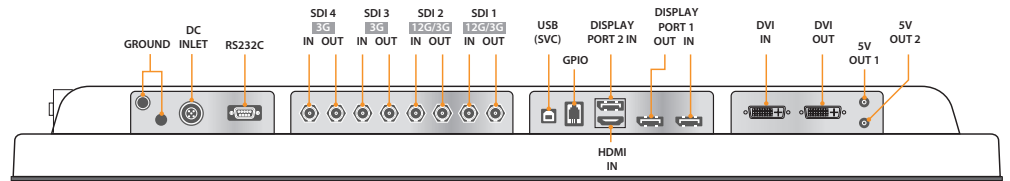

55 inch
FM-A5505DGC (Rev.02)



- OLED for high contrast, perfect blacks
- Supports HDR for an incredible image.
- 3D capability, glasses included.
- 3840 x 2160 resolution
- Brightness (range) 136-620 cd/m²
- Contrast Ratio (peak) 420,000:1

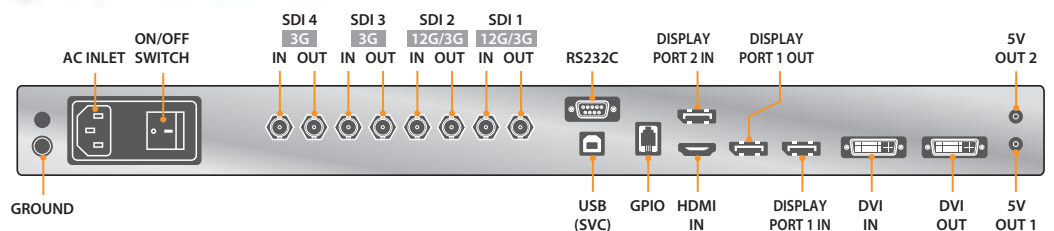

55 inch
FM-A5503DC (Rev.02)

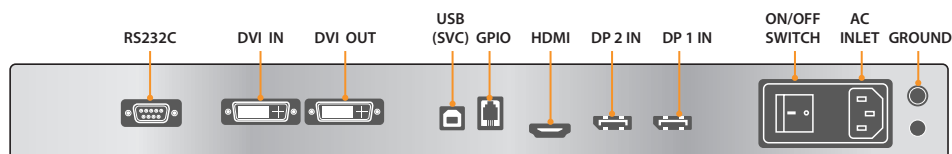

Surgical Visualization

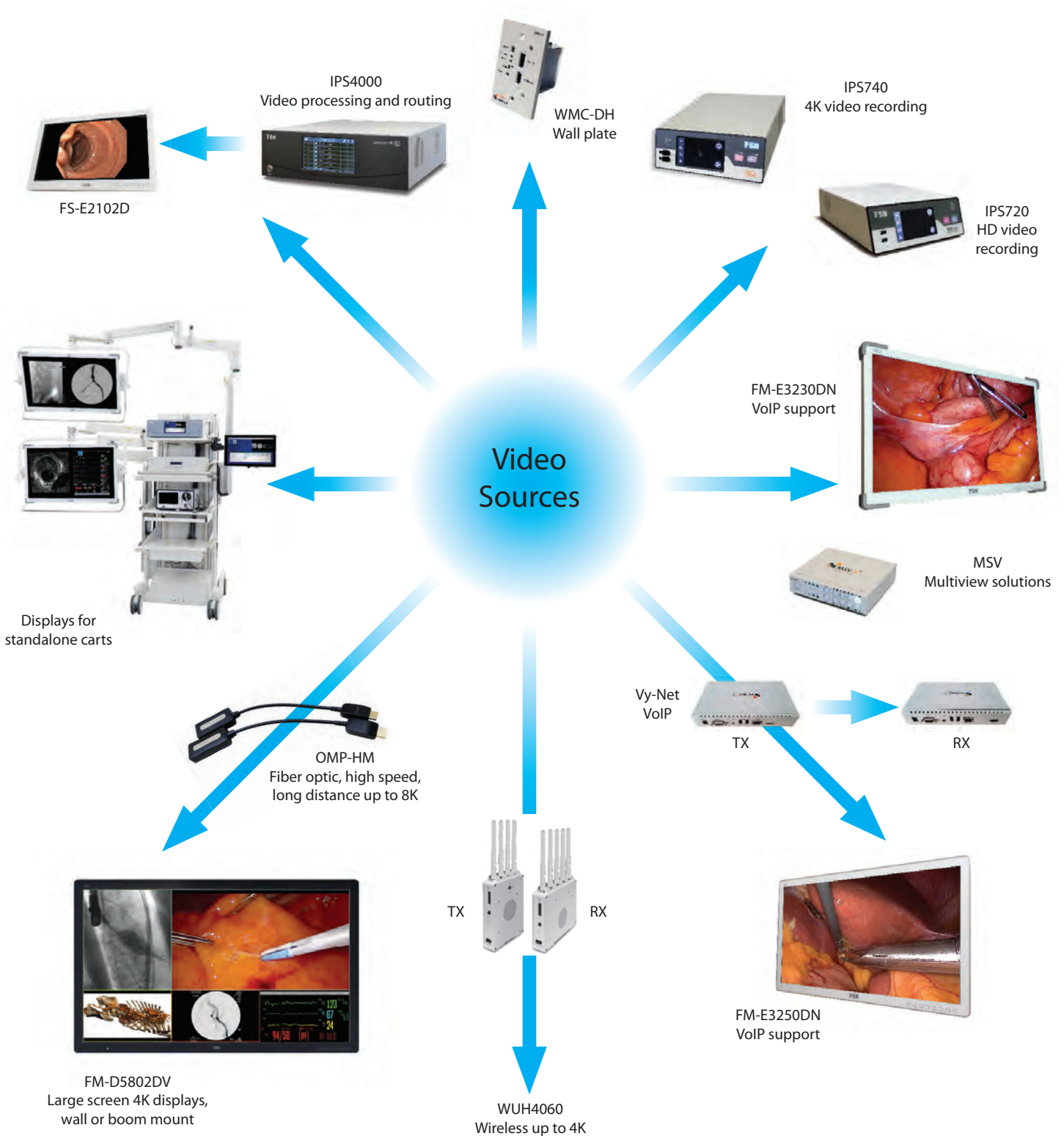

Medical Image Processing

IPS4000

IPS4000 (Control OR 4K) is FSN's next generation, high performance video processing system. It can be installed as a stand-alone video processor/controller, or integrated into larger imaging system packages, bringing its unique set of features to medical applications.

Use IPS4000 for controlling all aspects of medical video routing from source to destination, output layouts, network streaming, customizing icons and name assignments, and save/recall preset configurations.

IPS4000 has connections for external preview and interface control on a monitor or tablet, external peripheral control, Ethernet network, and USB 3.0.

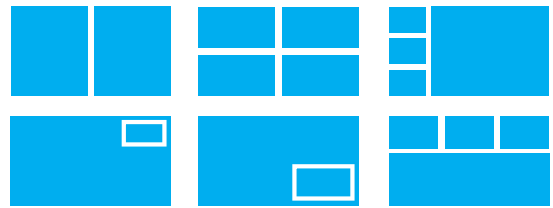

Selectable window layouts.

- 4K resolution
- Route source to destination, destination to source
- Assign icons and names to sources and destinations
- Save and recall preset configurations
- Input: DisplayPort, HDMI, 12G-SDI, analog
- Output: DisplayPort, HDMI
- Image control: contrast, brightness, color, zoom, pan
- Stream to external room
- Built-in touch screen
- External touchscreen control

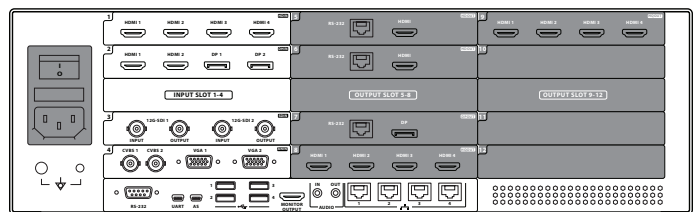
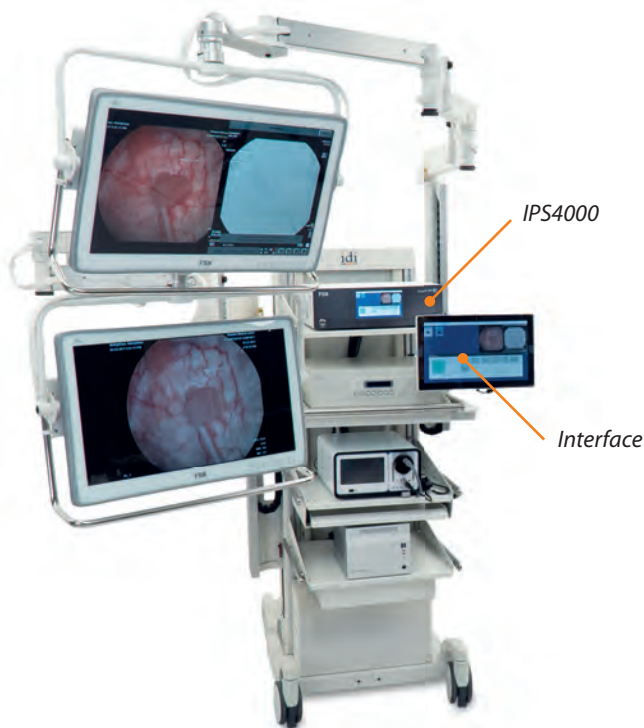

Several input/output configurations available.

IPS100A 4K Converter

IPS100A is a video signal converter that accepts quad SDI (3G or 12G) input up to 4K, and delivers single SDI (3G or 12G) or HDMI 2.0 output up to 4K.

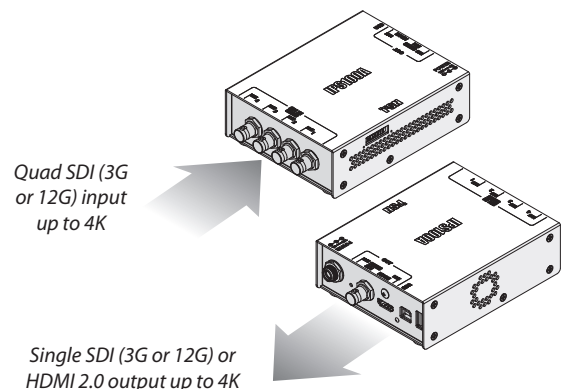
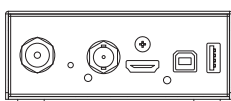

Recording and Archiving

IPS740DG



Record video and capture still images in crystal-clear 4K resolution. IPS740DG comes with a rich set of features that will upgrade any medical video application. These recorders also integrate with VACS® software for video archiving and collaboration.

- 4 TB of internal storage
- Record and playback video in 3D
- Integrated 5 inch touchscreen
- Foot pedal or hand trigger integration
- External monitor to control all recording, playback, saving functions, or to preview the active video signal



Worklist Retrieval.
Dicom Printing.
Send Files to PACS.



Connect an external control monitor for full screen interface viewing.

IPS720



The IPS720 Medical Digital Video Recorder offers HD image/still image capture (up to 1920x1080p) and medical session video recording (up to 1080p 60Hz). The system will simultaneously record to the 2 terabyte internal hard disk drive and an external USB flash drive. IPS720 integrates easily into medical IT workflows by utilizing: DICOM store, modality worklists, MPPS, appointment booking (HL7), and direct access to PACS.

Accession Number	Patients ID	Patient Name	Modality	Worklist Information
235	PID00190	OLIVER THOMAS	ES	Patient ID PID00190
344	PID02132	KARNEY NELSON	US	Patient Name OLIVER THOMAS
357	PID04930	FRED RALPH	DO	Patient Birth date 19750902
1299	PID11789	ABNER PAMELA	NM	Patient Weight 142
1300	PID00100	BALDWIN OLIVER	NM	Accession Number 235
1332	PID11789	ABNER PAMELA	XA	Admission ID A000211
1334	PID03755	LORENZO ALFREDO	XA	Modality
9001	100	WOLFE DIANA	SE	

The IPS720 user interface can be displayed on the front of the unit, or on an externally connected monitor.

- 2 Channel Recording!
- 3D Recording!



VACS®

High definition video, still captures, procedure notations, and DICOM files are considered valuable assets to medical professionals. The digital asset management capabilities found in a VACS® system make it easy to find and use content when and where it is needed.

VACS software resides on a computer server within a medical facility's secure network. Access to the VACS system is achieved through a password protected web browser interface. Medical video recorders from FSN integrate with VACS to retrieve electronic health records, capture video or still images during a procedure, and send DICOM compliant images to a PACS system.

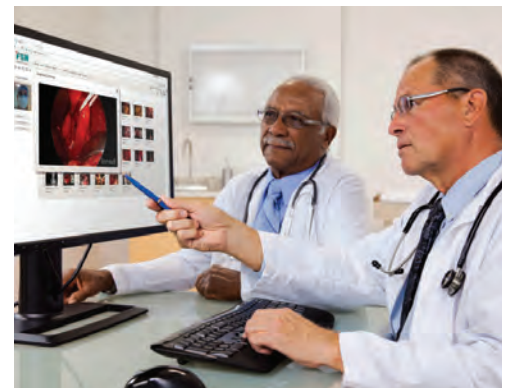
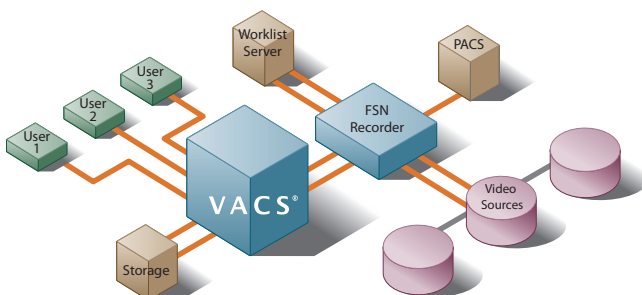

- Centralized digital asset management
- User friendly, secure
- Workflow compatible
- Ideal for presentations, education

Video Management

MSV3



With the Multi-Scaler Viewer, multiple video signals can be combined into one destination layout, such as quad screen, 1 large/3 small, or a user-customized layout. MSV3 accepts up to 4 inputs, each up to 4K resolution, and converts them to resolutions that will display on a single 4K screen. 2 outputs are available.

MSV3 is controlled by buttons on the unit's front face, or by a web-based PC interface that also offers live preview.

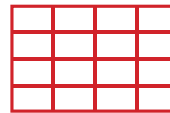

Group several MSV3 units in order to expand the number of sources that can be controlled.

Vy-Net3



This expandable Video Over IP network connects video sources to end-point destinations using 10GBASE-T Ethernet infrastructure. Vy-Net3 is modular and ready to expand when future needs change.

Additional features include:

- Compatible with SDVoE 4K over 10G SFP+
- HDMI/SDI/DP inputs selected by switch, HDMI output
- Web-based user interface
- Control options GPO, RS232, USB for KVM



**Receiver/Transmitter in the same device
(input/output in one box!)**

WUH4060

FSN's wireless transceiver system delivers uncompressed wireless audio and video, offers near-zero latency, and is free from lagging or stalling. WUH4060 is a proprietary system that does not interfere with other wireless signals.

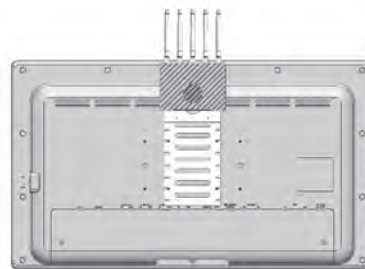

- Video resolution up to 4K 60Hz
- HDMI 2.0 and 12G
- Near zero latency (~1ms)
- Privacy data encryption
- Uncompressed AV streams



Transmitter (TX) **Receiver (RX)**

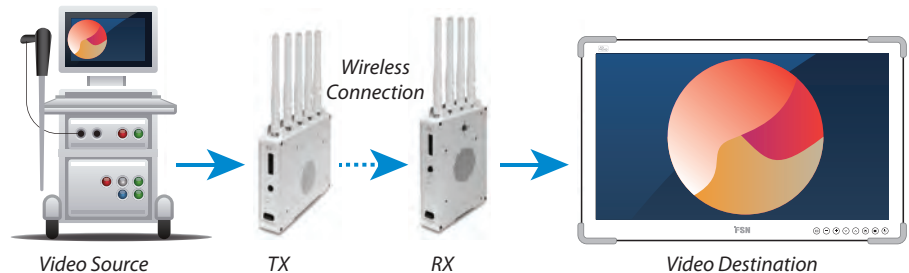

With WUH4060, medical equipment layouts can be flexible and completely mobile. Reduced wiring helps eliminate snagging or tripping hazards. Turn-around time is fast and efficient without the need to constantly connect and disconnect wires from equipment.

Optical Fiber Infrastructure

Fiber optic technology is a natural choice for medical imaging interconnects. It provides a compact and flexible conduit for light or data delivery, without electromagnetic interference.



OPHIT FTDS

4K Fiber Optic/DisplayPort Extenders

- DisplayPort standard V1.2a
- Up to 200 meters (656 ft.) between source and destination
- 3840 × 2160 or 4096 × 2160 @60Hz resolution
- External power supply (TX, RX)
- DPCP or HDCP compliant



OPHIT FTHS

4K Fiber Optic/HDMI Extenders

- HDMI standard V2.0a
- Up to 200 meters (656 ft.) distance
- 3840 × 2160 or 4096 × 2160 @60Hz resolution
- External power supply (TX, RX)
- HDCP compliant

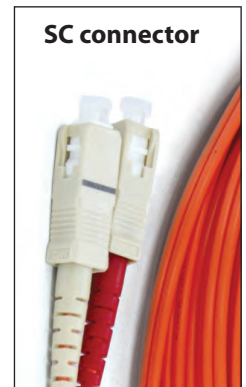

OPHIT OMP-HM

8K Fiber Optic/HDMI Extenders

- High speed, long distance up to 100m
- Supports OM3 fiber with 8 core MPO type connector
- OMP-HM, up to 7680 × 4320 @60Hz resolution, HDMI 2.1 compatible
- CEC, EDID, HDCP compliant



OMP-HM
HDMI (Pigtail)



MPO
connector

8K Fiber Optic/DisplayPort Extenders

- DisplayPort 1.4 compatible
- High speed, long distance up to 200m
- Compact and flexible
- DisplayPort configuration data (DPCD) compliant

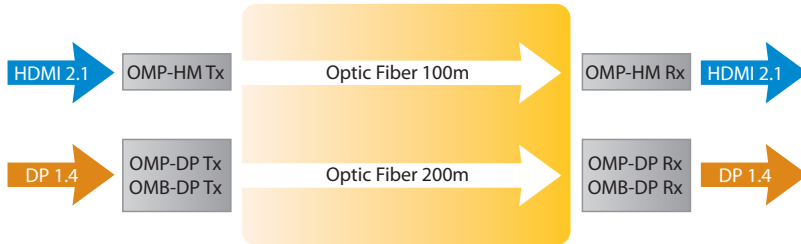
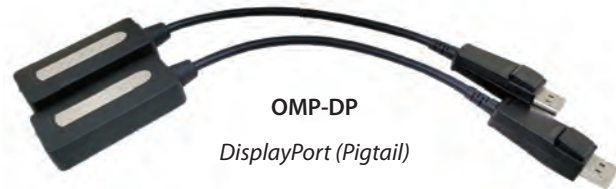

8K Fiber Optic/HDMI or DisplayPort Extenders

- HDMI 2.1 or DP 2.1, supports up to 8K@60 with DSC
- SC multimode fiber, max 100m distance
- Target mass production by 2Q25

4K Single-Format Wall Plate Converter

- WMC-SD converts 12G-SDI to 4K HDM
- WMC-DH converts 4K DP/HDMI to 4K HDMI
- MPO type output connectors
- Use with Ophit pigtail type extender

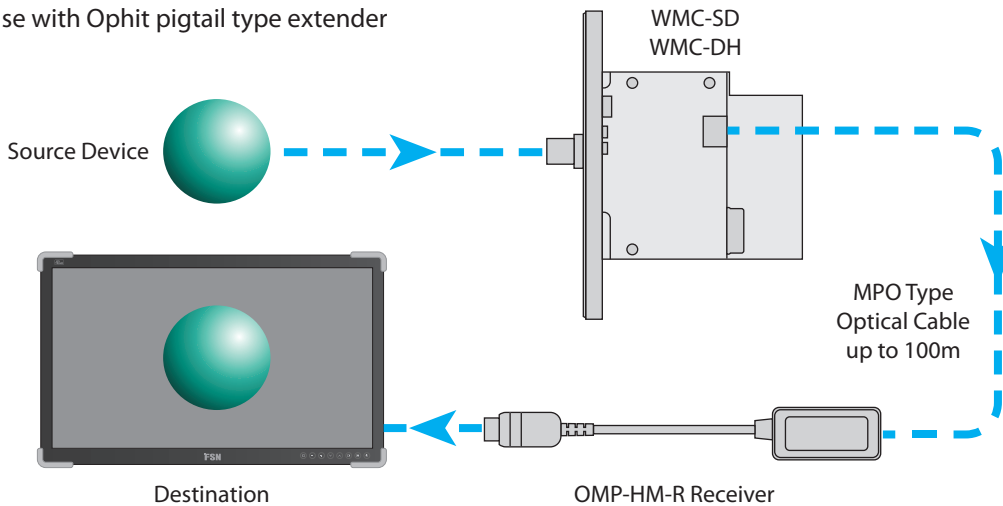

Optical Fiber Infrastructure

Fiber offers long distances without signal degradation. It is immune to electromagnetic interference (EMI), and designed with compact sizes for easy installation. Fiber is favored in medical AV environments (secure).



OPHIT OMCC

4K Multi-Format Cross Converter

- HDMI or DisplayPort to SDI format in 12G, 6G, 3G and HD with SDI bypass function
- DisplayPort 1.2 and 12G SDI input can also be converted to HDMI 2.0
- Push switch to select the input video format
- Slide switch to select the output video format
- LED indicator for lock status



The FSN mission is to provide advanced and reliable products while fostering innovation within our global partner relations. We have sales points throughout the world, The FSN team is here to help.

Sharing Your Vision

www.FSNmed.com
info@fsnmed.com



Foreseeson Custom Displays, Inc.
2210 E. Winston Road
Anaheim, CA 92806 USA
Tel: 714-300-0540
Fax: 714-300-0546

Latin America
Aventura, FL 33180 USA
Tel: 714-507-3855

Foreseeson Korea
B-408, U-Space2
670 Daewangpangyo-ro,
Bundang-gu, Seongnam-si
Gyeonggi-do, Republic of Korea
Tel: +82-31-8017-0780

Foreseeson GmbH
Industriestrasse 38a
63150 Heusenstamm, Germany
Tel: +49 6104 64398 0
Fax: +49 6104 64398 11

Foreseeson UK Ltd.
1st floor, Hornbeam House, 81 Bridge Road
East Molesey
Surrey
KT8 9HH
United Kingdom
Tel: +44 (0) 208 546 1047

Foreseeson (Shanghai)
Medical Equipment Co., Ltd.
Room 1010, Building A
1439 Wuzhong Road
Rhein Hongjing Center
Minhang District, Shanghai, China
Tel: 18521095596